

Wireless access point

# WEP-200L

User manual

Firmware version 2.3.2

IP address: 192.168.1.10

Username: admin

Password: password

## Contents

<b>1</b>	<b>Introduction .....</b>	<b>5</b>
1.1	Annotation.....	5
1.2	Symbols .....	5
<b>2</b>	<b>Device description.....</b>	<b>6</b>
2.1	Purpose.....	6
2.2	Device specification .....	6
2.3	The device technical parameters .....	7
2.4	Radiation patterns .....	9
2.5	Design .....	10
2.5.1	Main panel of the device .....	10
2.5.2	Top panel of the device .....	11
2.6	Light indication .....	12
2.7	Restore the default configuration .....	12
2.8	Delivery package .....	12
<b>3</b>	<b>Rules and recommendations for device installation .....</b>	<b>13</b>
3.1	Safety rules.....	13
3.2	Installation recommendations.....	13
3.3	Calculating the number of required access points .....	14
3.4	Channel selection for neighboring access points.....	14
<b>4</b>	<b>WEP-200L installation.....</b>	<b>16</b>
4.1	Wall mounting procedure.....	16
4.2	False ceiling mounting procedure .....	17
4.3	Removing the device from the bracket.....	17
<b>5</b>	<b>Device management via the web interface .....</b>	<b>18</b>
5.1	Getting started .....	18
5.2	Applying configuration and discarding changes.....	19
5.3	Web interface basic elements .....	20
5.4	The “Monitoring” menu .....	21
5.4.1	The “Wi-Fi Clients” submenu.....	21
5.4.2	The “WDS” submenu.....	22
5.4.3	The “Traffic Statistics” submenu .....	24
5.4.4	The “Scan Environment” submenu.....	26
5.4.5	The “Events” submenu .....	27
5.4.6	The “Network Information” submenu .....	28

5.4.7	The “Radio Information” submenu.....	30
5.4.8	The “Device Information” submenu .....	31
5.5	The “Radio” menu.....	32
5.5.1	The “Radio 2.4 GHz” submenu .....	32
5.5.2	The “Radio 5 GHz” submenu .....	36
5.5.3	The “Advanced” submenu.....	40
5.6	The “VAP” menu.....	41
5.6.1	The “Summary” submenu .....	41
5.6.2	The “VAP” submenu.....	42
5.7	The “WDS” menu.....	47
5.7.1	The “WDS” submenu.....	47
5.8	The “Network Settings” menu.....	48
5.8.1	The “System Configuration” submenu .....	48
5.8.2	The “Access” submenu .....	49
5.9	The “External Services” menu.....	50
5.9.1	The “Captive Portal” submenu.....	50
5.9.2	The “AirTune“ submenu .....	51
5.10	The “System” menu .....	52
5.10.1	The “Device Firmware Upgrade” submenu .....	52
5.10.2	The “Configuration” submenu .....	53
5.10.3	The “Reboot” submenu .....	53
5.10.4	The “Password” submenu .....	54
5.10.5	The “Log” submenu .....	54
5.10.6	The “Date and Time” submenu .....	55
<b>6</b>	<b>Managing the device using the command line .....</b>	<b>57</b>
6.1	Connection to the device.....	57
6.2	Network parameters configuration .....	58
6.2.1	Network parameters configuration via set-management-vlan-mode utility .....	59
6.2.2	IPv6 network parameters configuration.....	60
6.3	Virtual Wi-Fi access points (VAP) configuration.....	62
6.3.1	Configuration of VAP without encryption .....	62
6.3.2	Configuration of VAP with WPA-Personal security mode.....	63
6.3.3	Configuration of VAP with Enterprise authorization .....	64
6.3.4	Configuration of VAP with Captive Portal .....	65
6.3.5	Advanced VAP settings.....	66

6.4	Radio configuration .....	73
6.4.1	Advanced Radio settings .....	74
6.5	DHCP option 82 Configuration .....	76
6.6	WDS Configuration .....	77
6.7	System settings .....	78
6.7.1	Device firmware update.....	78
6.7.2	Device configuration management.....	78
6.7.3	Device reboot .....	79
6.7.4	Authentication Mode Configuration .....	79
6.7.5	Setting the date and time .....	80
6.7.6	Advanced system settings .....	80
6.8	APB service configuration.....	82
6.9	Monitoring .....	83
6.9.1	Wi-Fi clients .....	83
6.9.2	WDS.....	85
6.9.3	Device information .....	86
6.9.4	Certificate information .....	87
6.9.5	Network information .....	88
6.9.6	Wireless interfaces .....	89
6.9.7	Event logging .....	90
6.9.8	Environment scan .....	90
6.9.9	Spectrum analyzer .....	91
<b>7</b>	<b>The list of changes.....</b>	<b>92</b>

# 1 Introduction

## 1.1 Annotation

Modern tendencies of telecommunication development necessitate operators to search for the most optimal technologies, allowing to meet rapidly growing needs of subscribers, while maintaining at the same time consistency of business processes, development flexibility and reducing the costs of various services. Wireless technologies are spinning up more and more, and have paced a huge way for short time from unstable low-speed communication networks of low radius to broadband access networks equitable to speed of wired networks with high criteria to the quality of provided services.

The main purpose of WEP-200L is installation inside buildings as an access point to various resources creating a seamless wireless network from several identical access points ("Roaming"), if the coverage area is large enough.

This manual specifies intended purpose, main technical parameters, design, safe operation rules, and installation and configuration recommendations for WEP-200L.

## 1.2 Symbols

### Notes and warnings

 Notes contain important information, tips or recommendations on device operation and setup.

 Warnings are used to inform the user about harmful situations for the device and the user alike, which could cause malfunction or data loss.

## 2 Device description

### 2.1 Purpose

WEP-200L wireless access point is designed to provide the user access to high-speed and secure network.

The main purpose of the device is to create a Layer 2 wireless network at the junction with a wired network. WEP-200L connects to a wired network over 10/100/1000 Ethernet interface and using radio interfaces creates wireless high-speed access for devices that support Wi-Fi technology in the 2.4 GHz and 5 GHz bands.

The device contains 2 radio interfaces for organizing two physical wireless networks.

WEP-200L supports modern requirements for the the quality of services and allows transmitting the most important traffic in higher priority queues than normal. Prioritization is provided by the following QoS technologies: CoS (special tags in the VLAN packet field) and ToS (tags in the IP packet field). Support for traffic shaping on each VAP allows one to fully manage access, quality of service and restrictions both for all subscribers and for everyone in particular.

The device is designed for installation in offices (government institutions, conference rooms, laboratories, hotels, etc.). Ability to create virtual hotspots with different encryption types allows one to place WEP-200L in organizations where separation of access rights is required between ordinary users and dedicated user groups.

### 2.2 Device specification

#### Interfaces:

- 1 port of Ethernet 10/100/1000BASE-T (RJ-45) with PoE support;
- Wi-Fi 2.4 GHz IEEE 802.11b/g/n;
- Wi-Fi 5 GHz IEEE 802.11a/n/ac.

#### Functions:

##### *WLAN capabilities:*

- Support for IEEE 802.11a/b/g/n/ac standards;
- Support for IEEE 802.11r/k/v roaming standards;
- Data aggregation, including A-MPDU (Tx/Rx) and A-MSDU (Rx);
- WMM-based priorities and packet planning;
- Wireless bridging (WDS);
- Dynamic frequency selection (DFS);
- Support for hidden SSID;
- 14 virtual access points;
- Third-party access point detection;
- Spectrum analyzer;
- Auto channel selection.

##### *Network functions:*

- Auto-negotiation of speed, duplex mode and switching between MDI and MDI-X modes;
- IPv6;
- Support for VLAN;
- Support for 802.1X authentication;
- DHCP client;
- ACL;
- NTP;
- Syslog;
- GRE;
- Transmission of subscriber traffic out of tunnels.

**QoS functions:**

- Priority and profile-based packet scheduling;
- Bandwidth limitation for each VAP;
- Bandwidth limitation for each client;
- WMM parameters changing.

**Security:**

- Centralized authorization via RADIUS server (802.1X WPA/WPA2 Enterprise);
- WPA/WPA2 data encryption;
- Support for Captive Portal.

Figure 1 shows WEP-200L application diagram.

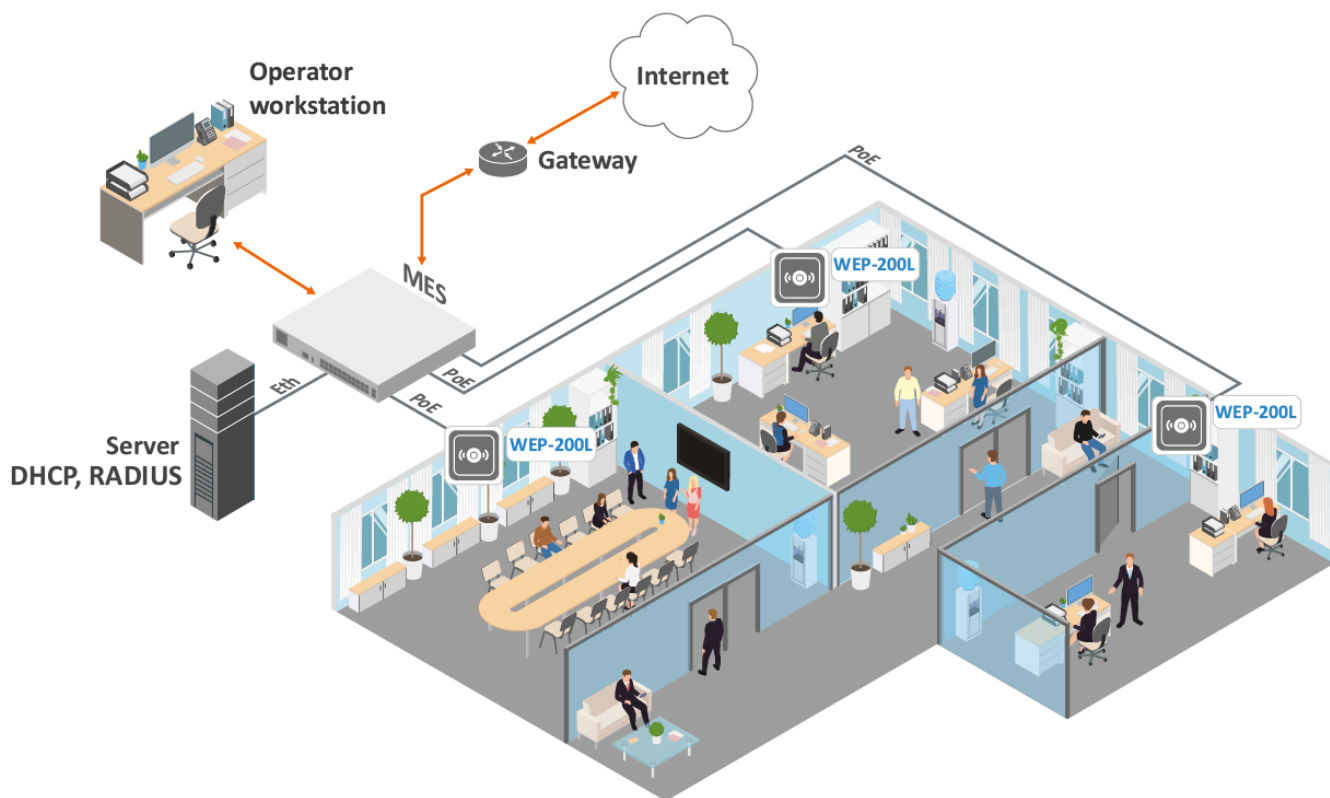

Figure 1 – WEP-200L application diagram

**2.3 The device technical parameters**

**Main specifications**

<b>WAN interface parameters</b>	
Number of ports	1
Electrical connector	RJ-45
Data rate	10/100/1000 Mbps, auto-negotiation
Standards	BASE-T

<b>Wireless interface parameters</b>	
Standards	802.11a/b/g/n/ac
Frequency range	2400–2483.5 MHz; 5150–5350 MHz, 5470–5850 MHz
Modulation	BPSK, QPSK, 16QAM, 64QAM, 256QAM
Operating channels	802.11b/g/n: 1–13 (2402–2482 MHz) 802.11a/n/ac: 36–64 (5170–5330 MHz) 100–144 (5490–5730 MHz) 149–165 (5735–5835 MHz)
Data rate	802.11a: up to 54 Mbps 802.11b: up to 11 Mbps 802.11g: up to 54 Mbps 802.11n: 2.4 GHz – up to 300 Mbps 5 GHz – up to 600 Mbps 802.11ac: up to 1733 Mbps
Maximum number of simultaneous sessions	2.4 GHz: 127 5 GHz: 127
Maximum output power of the transmitter	2.4 GHz: 18 dBm 5 GHz: 20 dBm
Built-in antenna gain	2.4 GHz: ~ 3 dBi 5 GHz: ~3 dBi
Receiver sensitivity	2.4 GHz: up to -92 dBm 5 GHz: up to -92 dBm
Security	Centralized authorization via RADIUS server (802.1X WPA/WPA2 Enterprise) WPA/WPA2 data encryption Support for Captive Portal
Supporting MIMO 2×2 for 2.4 GHz, MIMO 4×4 for 5 GHz	
<b>Control</b>	
Remote control	Web interface, Telnet, SSH, CLI, SNMP, NETCONF
Access restriction	By password, authentication via RADIUS server
<b>General parameters</b>	
Flash	128 MB SPI-NAND Flash
RAM	256 MB DDR3 RAM
Power supply	PoE 48 V/56 V (IEEE 802.3af-2003)
Maximum power consumption	No more than 12.95 W
Operating temperature range	From +5 to +40 °C
Relative humidity at 25 °C	Up to 80 %
Dimensions (diameter × height)	230 × 56 mm
Weight	0.46 kg
Service life	No less than 15 years



## 2.4 Radiation patterns

The figures below show the radiation patterns of the device.

### Measurement position

AZIMUTH (XY)

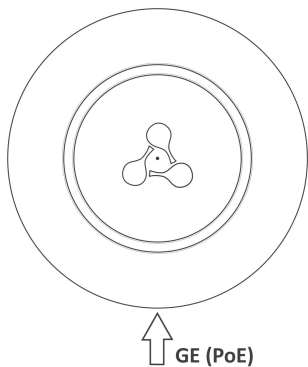

ELEVATION (XZ)

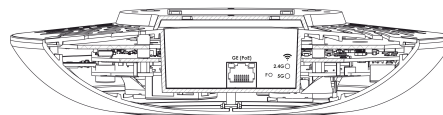

### 2.4 GHz band

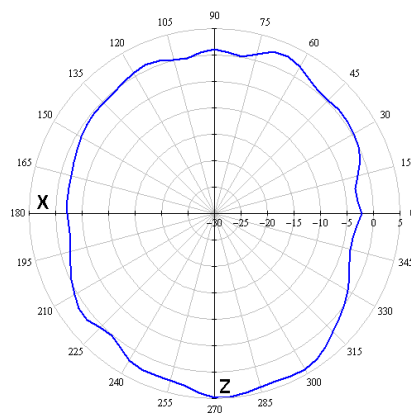
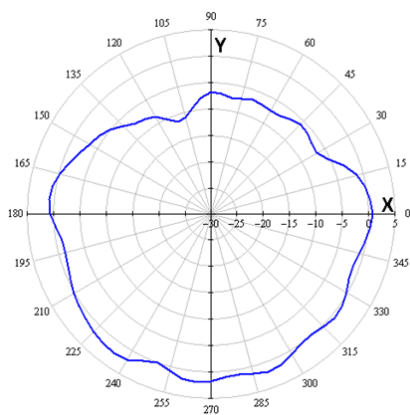

### 5 GHz band

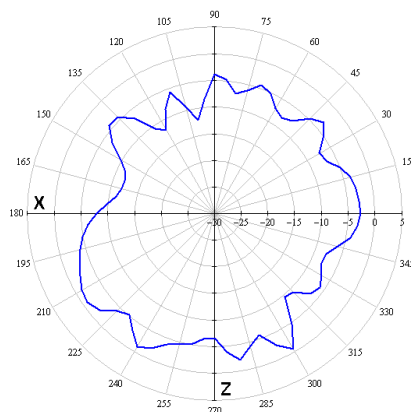
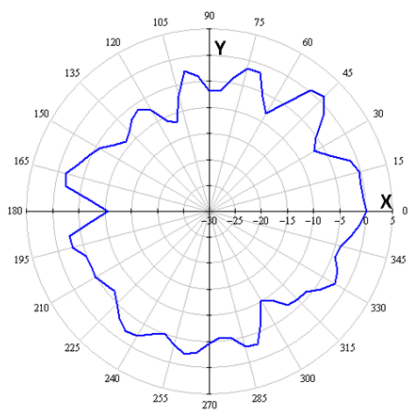

## 2.5 Design

WEP-200L enclosed in a plastic case.

### 2.5.1 Main panel of the device

WEP-200L main panel layout is shown in Figure 2.

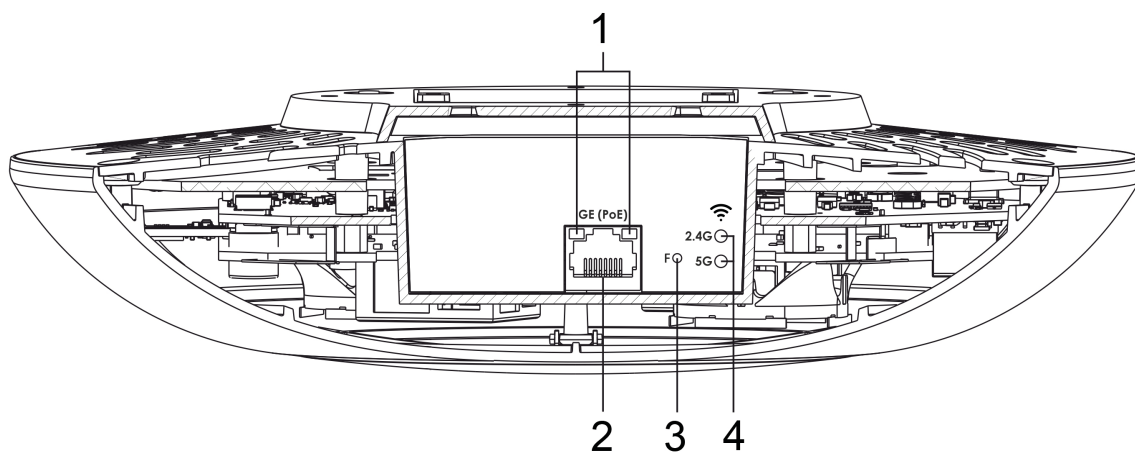

Figure 2 – WEP-200L main panel layout

The following indicator lights, connectors, and controls are placed on the WEP-200L main panel (see table 2).

Table 2 – Description of indicators, ports and controls

Element		Description
1	LAN	GE (PoE) port status LED
2	GE (PoE)	GE port for PoE connection
3	F	Factory reset button
4	Wi-Fi	Wi-Fi module activity LEDs

## 2.5.2 Top panel of the device

WEP-200L top panel layout is shown in Figure 3.

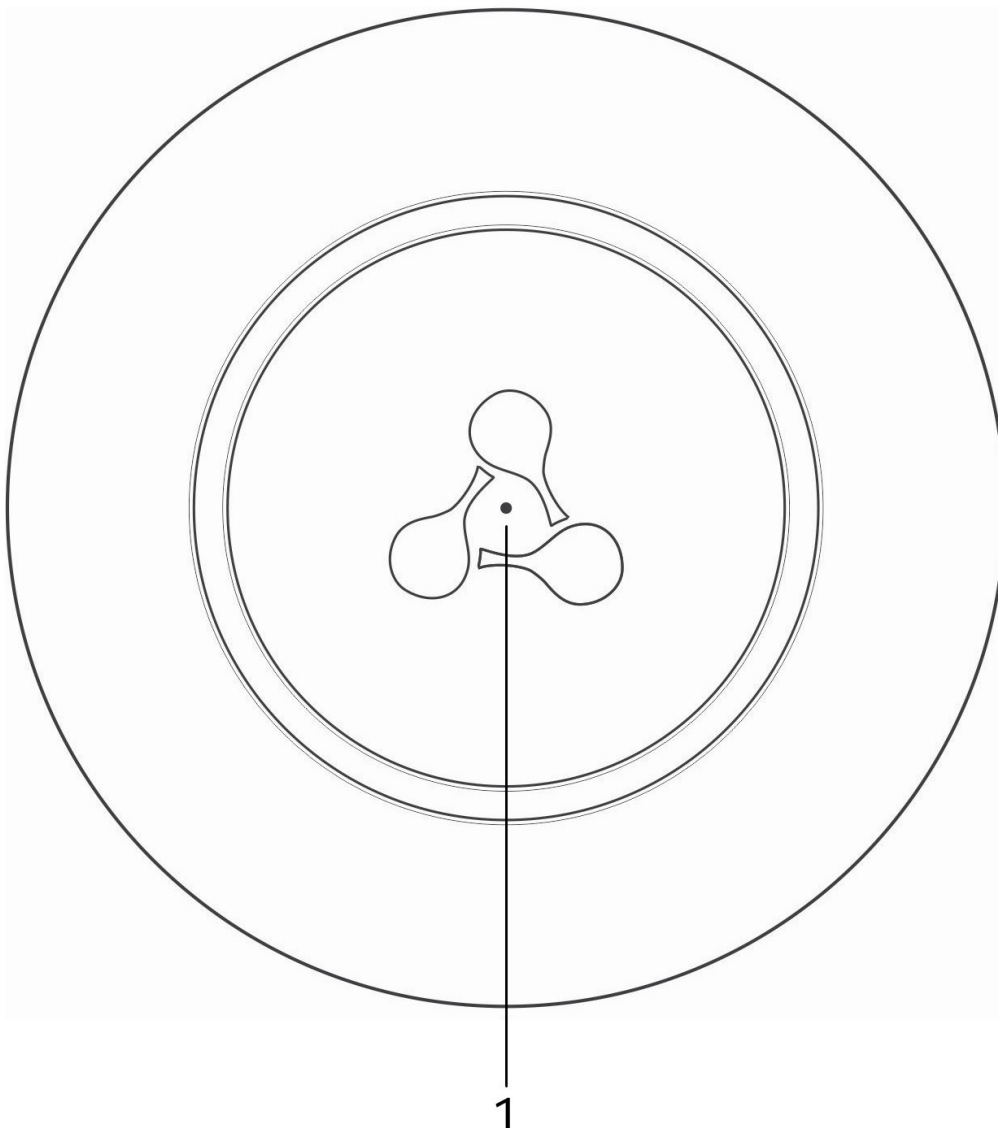

Figure 3 – WEP-200L top panel layout

Table 3 – Description of indicators

<b>Element</b>		<b>Description</b>
1	Power	Device operation status indicator

## 2.6 Light indication

The current status of the device is displayed using **Wi-Fi**, **LAN**, **Power** LEDs. The possible indicator states are described in Table 4.

Table 4 – Light indication of device status

LED	LED status	Description
<b>Wi-Fi</b>	Solid green	Wi-Fi network is active
	Flashing green	Data transmission over wireless network
<b>LAN</b>	Solid green (10, 100 Mbps)/ Solid orange (1000 Mbps)	The connection with a connected network device is established
	Flashing green	Packet data transmission over LAN interface
<b>Power</b>	Solid green	The device power supply is enabled, normal operation
	Solid orange	The device is loaded but IP address is not received via DHCP
	Solid red	The device is loading

## 2.7 Restore the default configuration

The device can be reset to the factory configuration using the “F” button on the device. When the device is loaded, press and hold the “F” button until the “Power” indicator is flashing.

The device will be rebooted automatically. DHCP client will be launched by default. If the address is not obtained via DHCP, the device will have the factory IP address – *192.168.1.10*, and the following netmask – *255.255.255.0*.

## 2.8 Delivery package

The delivery package includes:

- WEP-200L wireless access point;
- Mounting kit;
- Operation manual on a CD (optional);
- Technical passport.

## 3 Rules and recommendations for device installation

This section defines safety rules, installation recommendations, setup procedure and the device starting procedure.

### 3.1 Safety rules

1. Do not install the device near heat source and at places where temperature may reach values below +5 °C or higher 40 °C.
2. Do not use the device in rooms with high humidity. Do not expose the device to smoke, dust, water, mechanical vibration or shock.
3. Do not open the device case. There are no user serviceable parts inside.

⚠ To prevent overheating of the device components and malfunction of the device, do not block the ventilation holes with foreign objects and do not place objects on the equipment surface.

### 3.2 Installation recommendations

1. The recommended installation position: horizontal, on the ceiling.
2. Before installing the device and turning it on, check the device for visible mechanical defects. If defects are observed, stop the device installation, fill in the corresponding act and contact the supplier.
3. If your device has been exposed to the cold for a long period of time, let it warm up at room temperature for two hours before starting work. If your device has been exposed to high humidity for a long period of time, let it stay under normal conditions for at least 12 hours before turning it on.
4. When placing your device, in order to provide the best Wi-Fi coverage consider the following rules:
  - Install the device at the center of a wireless network;
  - Minimize the number of barriers (walls, ceilings, furniture, and etc.) between WEP-200L and other wireless network devices;
  - Do not install the device near (about 2 m) electrical and radio devices;
  - It is not recommended to use radiophone and other equipment operating at the frequency of 2.4 GHz or 5 GHz, within the range of a Wi-Fi network;
  - Obstacles like glass/metal constructions, brick/concrete walls, water cans and mirrors can significantly reduce Wi-Fi action radius. It is not recommended to place the device inside a false ceiling as metal frame causes multipath signal propagation and signal attenuation.
5. When installing several access points, cell action radius must overlap with action radius of a neighboring cell at the level from -65 to -70 dBm. It is allowed to reduce the signal level to -75 dBm at cell boundaries, if it is not intended to use VoIP, video streaming and other sensitive to losses traffic in wireless network.

### 3.3 Calculating the number of required access points

To calculate the required number of access points, evaluate the required coverage zone. For more accurate assessment, it is necessary to make a radio examination of the room. Approximate radius of WEP-200L coverage area with a good-quality signal in case of mounting on a ceiling in typical office: 2.4 GHz – 40–50 m, 5 GHz – 20–30 m. In the absence of obstacles, the coverage radius: 2.4 GHz – up to 100 m, 5 GHz – up to 60 m. Table 5 describes rough attenuation values.

Table 5 – Attenuation values

Material	Change of signal level, dB	
	2.4 GHz	5 GHz
Organic glass	-0.3	-0.9
Brick	-4.5	-14.6
Glass	-0.5	-1.7
Plaster slab	-0.5	-0.8
Wood laminated plastic	-1.6	-1.9
Plywood	-1.9	-1.8
Plaster with wirecloth	-14.8	-13.2
Breezeblock	-7	-11
Metal lattice (mesh 13 × 6 mm, metal 2 mm)	-21	-13

### 3.4 Channel selection for neighboring access points

It is recommended to set non-overlapping channels to avoid interchannel interference among neighboring access points.

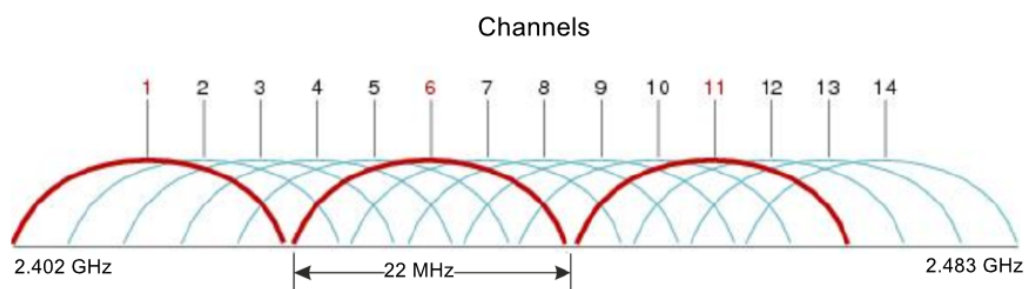

Figure 4 – General diagram of frequency channel overlap in the range of 2.4 GHz

Example of channel allocation scheme among neighboring access points in frequency range of 2.4 GHz when channel width is 20 MHz, see Figure 5.

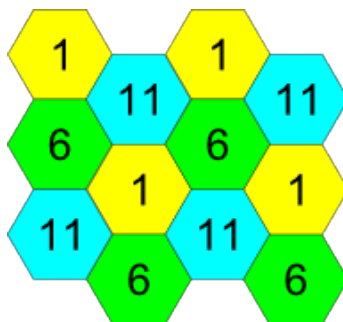

Figure 5 – Scheme of channel allocation among neighboring access points in the frequency range of 2.4 GHz when channel width is 20 MHz

Similarly, the procedure of channel allocation is recommended to save for access point allocation between floors, see Figure 6.

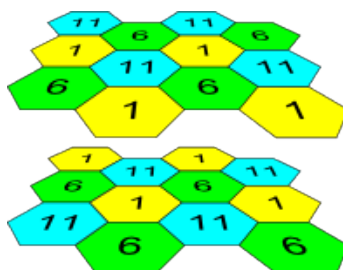

Figure 6 – Scheme of channel allocation between neighboring access points that are located between floors  
 With a channel width of 40 MHz there are no non-overlapping channels in the 2.4 GHz band. In such cases, it is required to select channels maximally separated from each other.

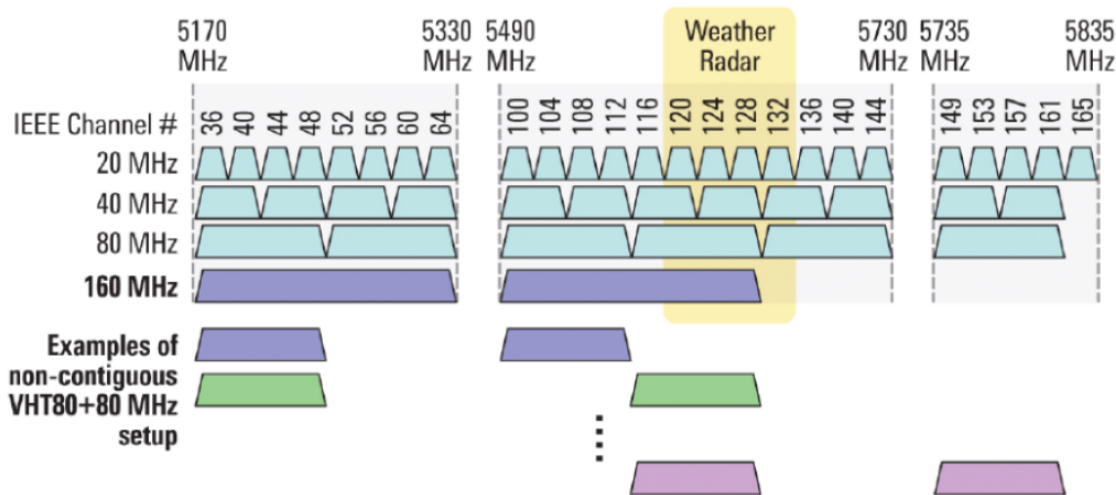

Figure 7 – Channels used in the 5 GHz band when channel width is 20, 40 or 80 MHz

## 4 WEP-200L installation

The device can be installed on the plain surface (wall or ceiling) in accordance with the safety instructions and recommendations listed above.

The device delivery package includes required mounting kit to attach the device to plain surface.

### 4.1 Wall mounting procedure

1. Fix the plastic bracket (included in the delivery package) to the wall:

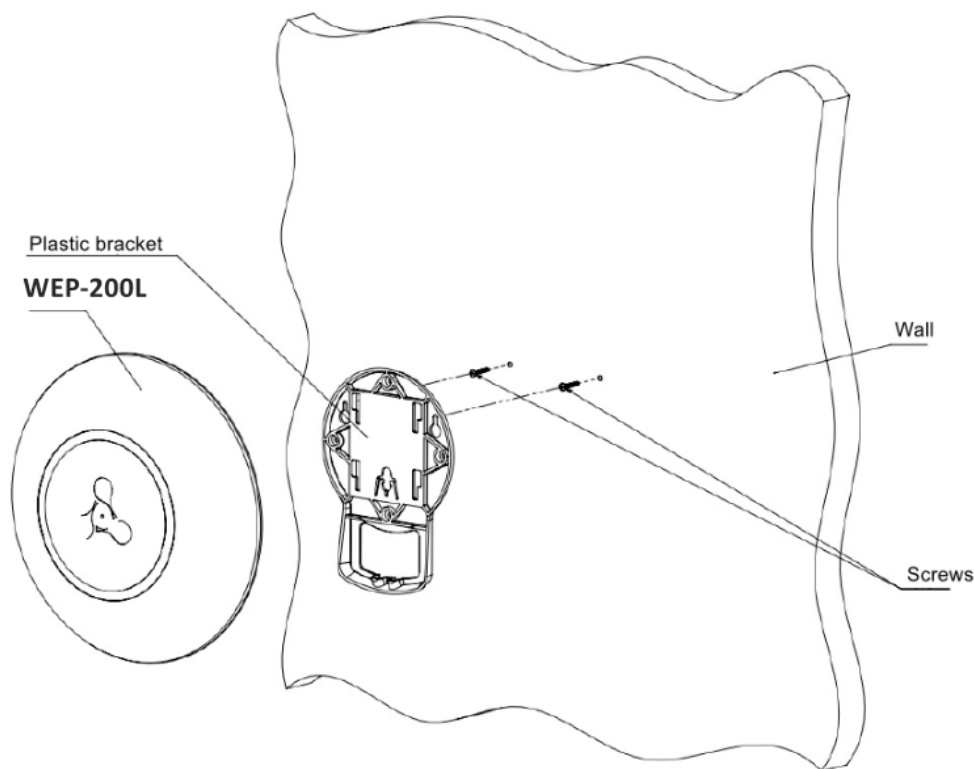

Figure 8 – Attaching the bracket to a wall

- An example of placing the plastic bracket is shown in Figure 8.
- When installing the bracket, pass wires through the corresponding channels of the bracket, see Figure 8.
- Align screw holes on the bracket with the corresponding screw holes on the surface. Screw the bracket to the surface using a screwdriver.

2. Install the device.

- Connect cables to corresponding connectors of the device. Description of the connectors is given in the section [Design](#).
- Align the device with the bracket and secure the position by pulling it down.



## 4.2 False ceiling mounting procedure

- ⚠ It is not recommended to place WEP-200L from the inside of the false ceiling, as the metal frame causes signal multipath propagation and its attenuation when passing through the lattice of the false ceiling frame.

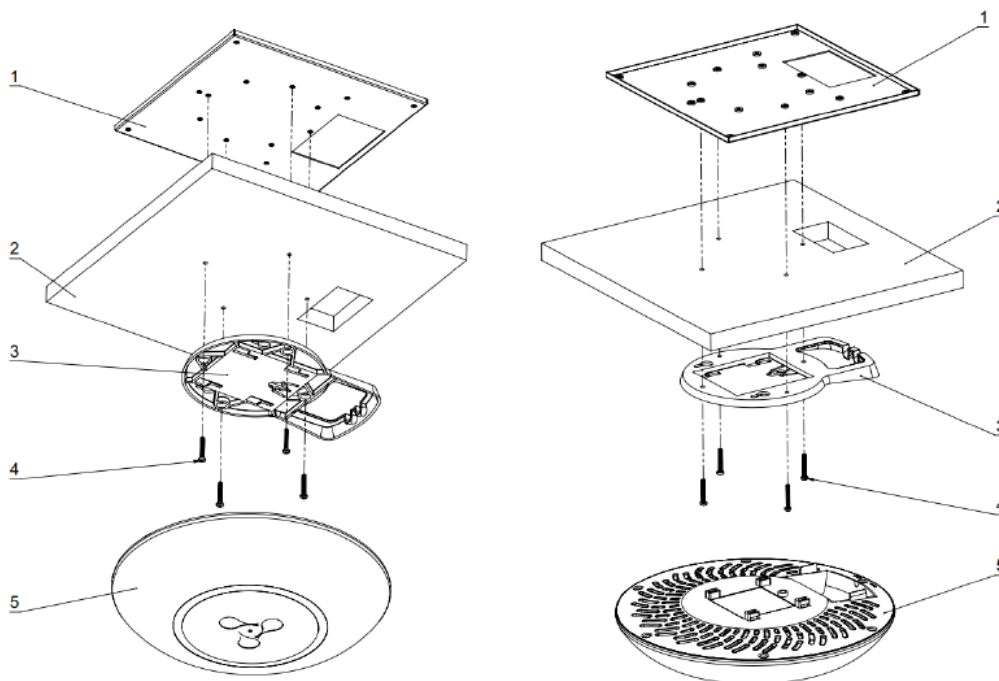

1 – metal bracket; 2 – Armstrong panel; 3 – plastic bracket; 4 – screws; 5 – device.

Figure 9 – Mounting the device on a false ceiling

### 1. Attach the metal and plastic brackets to the ceiling (Figure 9).

- Fasten the plastic bracket (3) on false ceiling with the metal bracket (1) in the following order: metal bracket -> Armstrong panel -> plastic bracket.
- In the Armstrong panel, make a hole with the the size of the metal bracket. Run the wires through this hole.
- Align the holes on the metal bracket, Armstrong panel and plastic bracket. Next, align the screw holes on the plastic bracket with the same holes on the metal bracket. Use a screwdriver to fix brackets with screws.

### 2. Install the device.

- Connect cables to corresponding connectors of the device. Description of the connectors is given in the section [Design](#).
- Align the device with the plastic bracket and secure the position by turning the device clockwise.

## 4.3 Removing the device from the bracket

To remove the device from the bracket:

1. Pull the device up (Figure 8).
2. Remove the device.

## 5 Device management via the web interface

### 5.1 Getting started

In order to start the operation, you should connect to the device via WAN interface using a web browser:

1. Open a web browser, for example, Firefox, Opera, Chrome.
2. Enter the device IP address in the browser address bar.

- ✓ Factory IP address: 192.168.1.10, subnet mask: 255.255.255.0. By default, the device is capable to obtain an IP address via DHCP.

When the device is successfully detected, username and password request page will be shown in the browser window:

3. Enter username into "Login" and password into "Password" field.

- ✓ Factory settings: login: **admin**, password: **password**.

4. Click "Log in". A menu for monitoring the device status will open in a browser window.

5. If necessary, select the information display language. Russian and English languages are available for web interface.

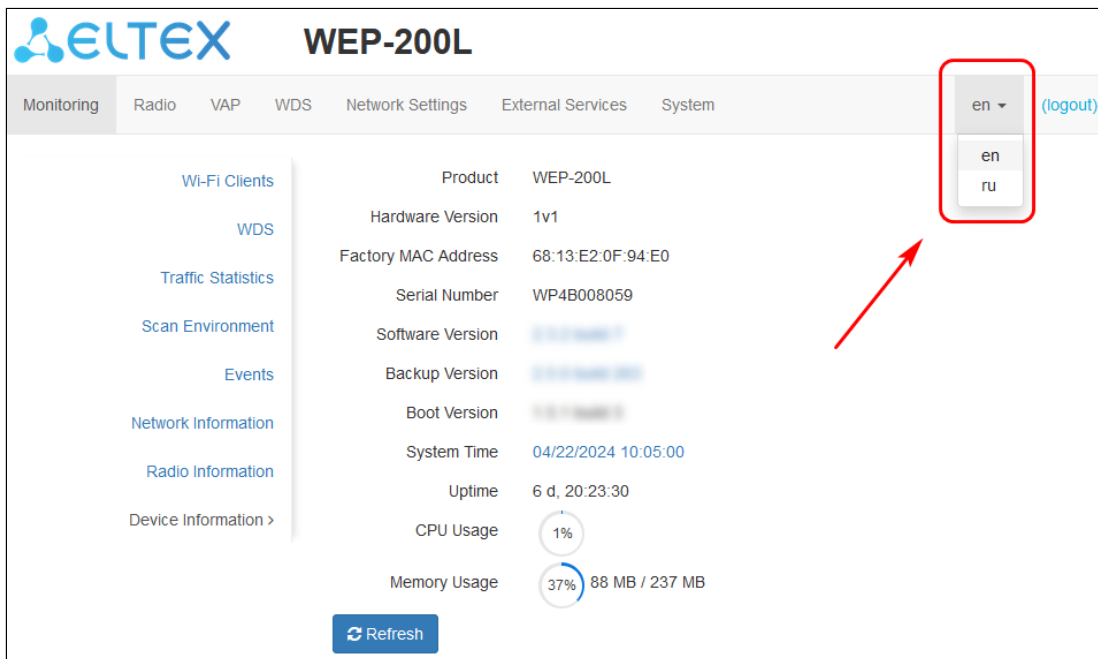





## 5.2 Applying configuration and discarding changes

### 1. Applying configuration

Clicking  starts the process of saving the configuration to the device flash memory and applying the new settings. All the settings come into operation without device rebooting.

The WEP-200L web interface has a visual indication of the current status of the setting applying process (Table 6).

Table 6 – Visual indication of the current status of the setting application process

Image	State description
	After clicking "Apply", the process of settings saving to device memory is launched. This is indicated by the  icon in the tab name and on the "Apply" button.
	The  icon in the tab name indicates about successful saving and application of the settings.

### 2. Discarding changes

The button for discarding changes appears as follows:

 Cancel

The changes can be discarded only before clicking "Apply". If you click "Apply", all the changed parameters will be applied and saved to device memory. After clicking "Apply", return to the previous settings will not be possible.

### 5.3 Web interface basic elements

Navigation elements of the web interface are shown in the figure below.



User interface window is divided into five general areas:

1. Menu tabs categorize the submenu tabs: **Monitoring, Radio, VAP, WDS, Network Settings, External Services, System.**
2. Interface language selection and Logout button designed to end a session in the web interface under a given user.
3. Submenu tabs allow one to control settings field.
4. Device configuration field displays data and configuration.
5. Information field displays current firmware version.

## 5.4 The “Monitoring” menu

In the “**Monitoring**” menu, the current system state can be viewed.

### 5.4.1 The “Wi-Fi Clients” submenu

The “**Wi-Fi Clients**” submenu displays information about the status of connected Wi-Fi clients.

Information on connected clients is not displayed in real time. In order to update the information on the page, click “Refresh”.

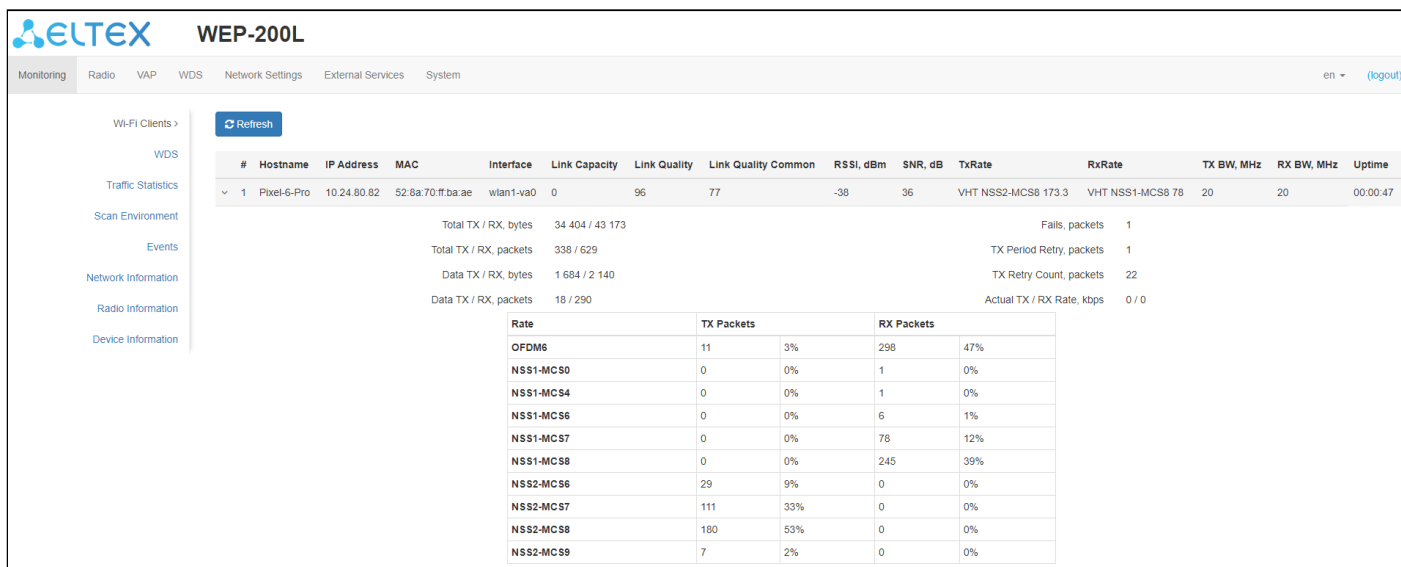

The screenshot shows the WEP-200L monitoring interface. The top navigation bar includes 'Monitoring', 'Radio', 'VAP', 'WDS', 'Network Settings', 'External Services', and 'System'. The 'Monitoring' menu is expanded to show 'Wi-Fi Clients' with a 'Refresh' button. The main content area displays a table of connected Wi-Fi clients and a detailed view of the selected client's performance metrics.

#	Hostname	IP Address	MAC	Interface	Link Capacity	Link Quality	Link Quality Common	RSSI, dBm	SNR, dB	TxRate	RxRate	Tx BW, MHz	Rx BW, MHz	Uptime
1	Pixel-6-Pro	10.24.80.82	52:8a:70:ff:ba:ae	wlan1-va0	0	96	77	-38	36	VHT NSS2-MCS8 173.3	VHT NSS1-MCS8 78	20	20	00:00:47

Total TX / RX, bytes		Fails, packets	
34 404 / 43 173		1	

Total TX / RX, packets		TX Period Retry, packets	
338 / 629		1	

Data TX / RX, bytes		TX Retry Count, packets	
1 684 / 2 140		22	

Data TX / RX, packets		Actual TX / RX Rate, kbps	
18 / 290		0 / 0	

Rate	TX Packets		RX Packets	
OFDM6	11	3%	298	47%
NSS1-MCS0	0	0%	1	0%
NSS1-MCS4	0	0%	1	0%
NSS1-MCS6	0	0%	6	1%
NSS1-MCS7	0	0%	78	12%
NSS1-MCS8	0	0%	245	39%
NSS2-MCS6	29	9%	0	0%
NSS2-MCS7	111	33%	0	0%
NSS2-MCS8	180	53%	0	0%
NSS2-MCS9	7	2%	0	0%

- **#** – number of the connected device in the list;
- **Hostname** – network name of the device;
- **IP address** – IP address of the connected device;
- **MAC address** – MAC address of the connected device;
- **Interface** – WEP-200L interaction interface with the connected device;
- **Link Capacity** – parameter that displays how effectively the access point uses modulation to transmit. It is calculated based on the number of packets transmitted on each modulation to the client, and reduction factors. The maximum value is 100% (it means that all packets are transmitted to the client at maximum modulation for the maximum nss type supported by the client). The minimum value is 2% (in case when packets are transmitted on nss1mcs0 modulation for a client with MIMO 3x3 support). The parameter value is calculated for the last 10 seconds;
- **Link Quality** – parameter that displays the state of the link to the client, calculated based on the number of retransmit packets sent to the client. The maximum value is 100% (all transmitted packets were sent on the first attempt), the minimum value is 0% (no packets were successfully sent to the client). The parameter value is calculated for the last 10 seconds;
- **Link Quality Common** – parameter that displays the status of the link to the client, calculated based on the number of retransmit packets sent to the client. The maximum value is 100% (all transmitted packets were sent on the first attempt), the minimum value is 0% (no packets were successfully sent to the client). The parameter value is calculated for the entire time of the client connection;
- **RSSI** – received signal level, dBm;
- **SNR** – signal/noise ratio, dB;
- **TxRate** – channel data rate of transmission, Mbps;
- **RxRate** – channel data rate of reception, Mbps;
- **Tx BW** – transmission bandwidth, MHz;
- **Rx BW** – reception bandwidth, MHz;
- **Uptime** – Wi-Fi client connection time.

To display more detailed information on a particular client, select it from the list. A detailed description includes the following options:

- *Total TX/RX, bytes* – number of bytes sent/received on the connected device;
- *Total TX/RX, packets* – number of packets sent/received on the connected device;
- *Data TX/RX, bytes* – number of data bytes sent/received on the connected device;
- *Data TX/RX, packets* – number of data packets sent/received on the connected device;
- *Fails, packets* – number of packets sent with errors on the connected device;
- *TX Period Retry, packets* – number of retries of transmission to the connected device for the last 10 seconds;
- *TX Retry Count, packets* – number of retries of transmission to the connected device during the entire connection;
- *Actual TX/RX Rate, Kbps* – current traffic transmission rate at the moment.

#### 5.4.2 The “WDS” submenu

The "WDS" submenu displays information about the status of WEP-200L access points connected via WDS.

The screenshot shows the WDS submenu in the ELTEX WEP-200L interface. It features a table with columns for device identification and performance metrics. Below the table, there are summary statistics for total TX/RX bytes and packets, data TX/RX bytes and packets, and actual TX/RX rate. A detailed modulation statistics table is also present at the bottom.

#	Hostname	IP Address	MAC	Interface	Link Capacity	Link Quality	Link Quality Common	RSSI, dBm	SNR, dB	TxRate	RxRate	TX BW, MHz	RX BW, MHz	Uptime
1	WEP-200L	10.24.80.157	68:13:e2:0f:45:48	wlan1	60	100	93	-44	34	VHT NSS3- MCS4 117	VHT NSS4- MCS3 104	20	20	00:02:14

Total TX / RX, bytes	31 551 / 14 902	Fails, packets	0
Total TX / RX, packets	215 / 115	TX Period Retry, packets	0
Data TX / RX, bytes	24 306 / 9 818	TX Retry Count, packets	9
Data TX / RX, packets	206 / 106	Actual TX / RX Rate, kbps	1 / 0

Rate	TX Packets		RX Packets	
OFDM6	9	4%	9	8%
OFDM54	1	0%	0	0%
NSS1-MCS0	7	3%	8	7%
NSS1-MCS1	9	4%	2	2%

- *#* – number of the connected device in the list;
- *Hostname* – device network name;
- *IP Address* – IP address of the connected device;
- *MAC* – MAC address of the connected device;
- *Interface* – interface of WEP-200L and the connected device interaction;
- *Link Capacity* – parameter that displays how effectively the access point uses modulation to transmit. It is calculated based on the number of packets transmitted on each modulation to the client, and reduction factors. The maximum value is 100% (it means that all packets are transmitted to the client at maximum modulation for the maximum nss type supported by the client). The minimum value is 2% (in case when packets are transmitted on nss1mcs0 modulation for a client with MIMO 3x3 support). The parameter value is calculated for the last 10 seconds;
- *Link Quality* – parameter that displays the state of the link to the client, calculated based on the number of retransmit packets sent to the client. Maximum value – 100% (all transmitted packets were sent on the first attempt), minimum value – 0% (no packet to the client was successfully sent). The parameter value is calculated for the last 10 seconds;
- *Link Quality Common* – parameter that displays the status of the link to the client, calculated based on the number of retransmit packets sent to the client. The maximum value is 100% (all transmitted packets were sent on the first attempt), the minimum value is 0% (no packets were successfully sent to the client). The parameter value is calculated for the entire time of the client connection;
- *RSSI* – received signal level, dBm;
- *SNR* – ratio signal/noise, dB;
- *TxRate* – channel data rate of transmission, Mbps;

- *RxRate* – channel data rate of reception, Mbps;
- *TX BW* – transmission bandwidth, MHz;
- *RX BW* – reception bandwidth, MHz;
- *Uptime* – Wi-Fi client connection time.

To display more detailed information on a particular client, select it from the list. A detailed description includes the following options:

- *Total TX/RX, bytes* – number of bytes sent/received on the connected device;
- *Total TX/RX, packets* – number of packets sent/received on the connected device;
- *Data TX/RX, bytes* – number of data bytes sent/received on the connected device;
- *Data TX/RX, packets* – number of data packets sent/received on the connected device;
- *Fails, packets* – number of packets sent with errors on the connected device;
- *TX Period Retry, packets* – number of retries of transmission to the connected device for the last 10 seconds;
- *TX Retry Count, packets* – the number of retries of transmission to the connected device during the entire connection;
- *Actual TX/RX Rate, Kbps* – current traffic transmission rate at the moment.

### 5.4.3 The “Traffic Statistics” submenu

The “**Traffic Statistics**” section displays the graphs of the transmitted/received traffic speed for the last 3 minutes, as well as statistics on the amount of transmitted/received traffic since the access point was turned on.

The LAN Tx/Rx graph shows the speed of the transmitted/received traffic via Ethernet interface of the access point for the last 3 minutes. The graph is automatically updated every 6 seconds.

The WLAN0 and WLAN1 Tx/Rx graphs show the rate of transmitted/received traffic via Radio 2.4 GHz and Radio 5 GHz interfaces for the last 3 minutes. The graph is automatically updated every 6 seconds.

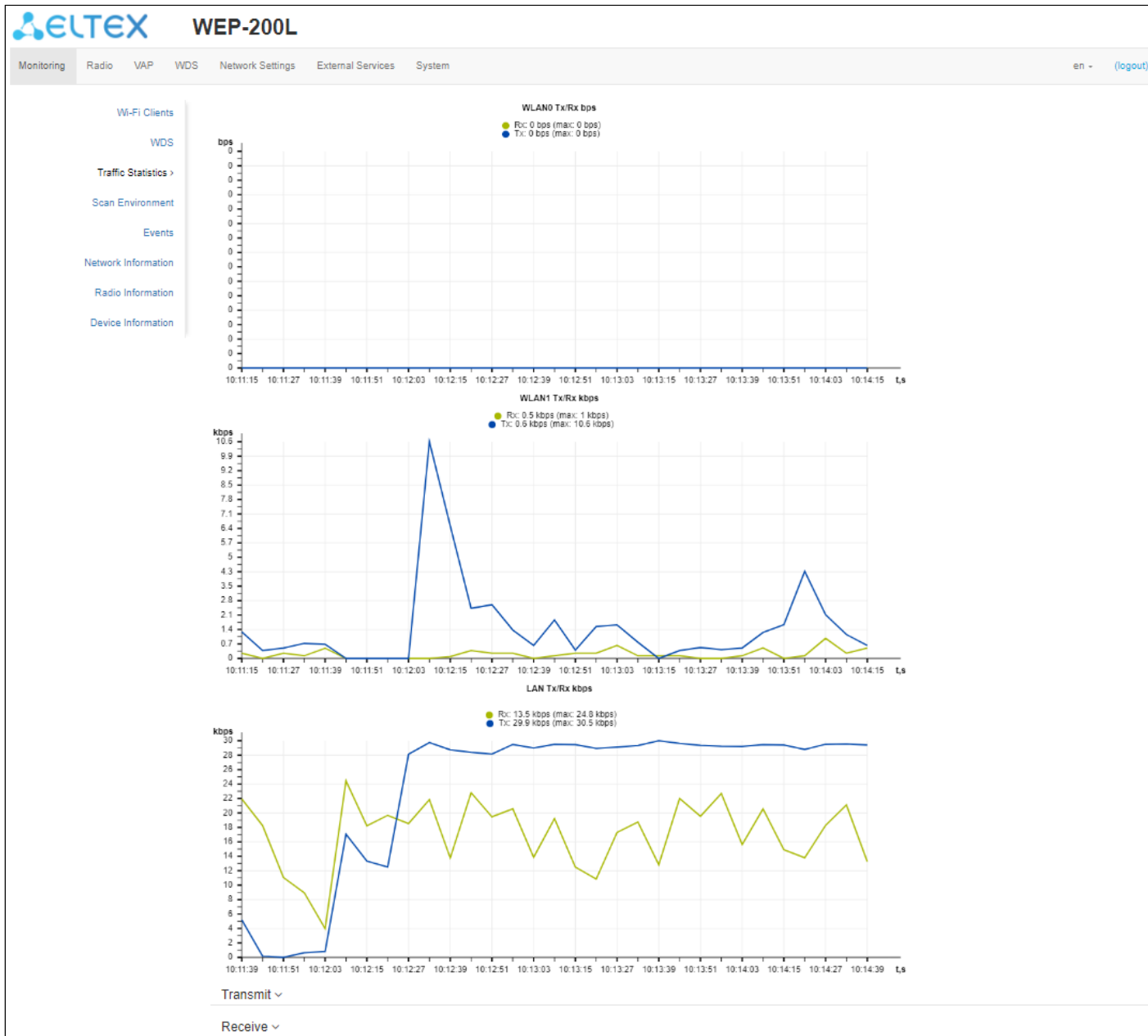



“Transmit” table description:

- *Interface* – name of the interface;
- *Total packets* – number of successfully sent packets;
- *Total bytes* – number of successfully sent bytes;
- *Total drop* – number of rejected packets;
- *Errors* – number of errors.

Transmit ▾				
Interface	Total Packets	Total Bytes	Total Drop	Errors
LAN	7608	4926363	0	0
WLAN0	0	0	0	0
WLAN1	651	74047	12	111
wlan0-va0	0	0	0	0
wlan0-va1	0	0	0	0
wlan0-va2	0	0	0	0
wlan0-va3	0	0	0	0
wlan0-va4	0	0	0	0

“Receive” table description:

- *Interface* – name of the interface;
- *Total packets* – number of successfully received packets;
- *Total bytes* – number of successfully received bytes;
- *Total drop* – number of rejected packets;
- *Errors* – number of errors.

Receive ▾				
Interface	Total Packets	Total Bytes	Total Drop	Errors
LAN	444367	56295830	0	0
WLAN0	0	0	0	374350
WLAN1	255	46084	0	0
wlan0-va0	0	0	0	0
wlan0-va1	0	0	0	0
wlan0-va2	0	0	0	0
wlan0-va3	0	0	0	0
wlan0-va4	0	0	0	0
wlan0-va5	0	0	0	0

#### 5.4.4 The “Scan Environment” submenu

In the “**Scan Environment**” submenu, scanning of the surrounding radio and detection of neighboring access points are carried out.

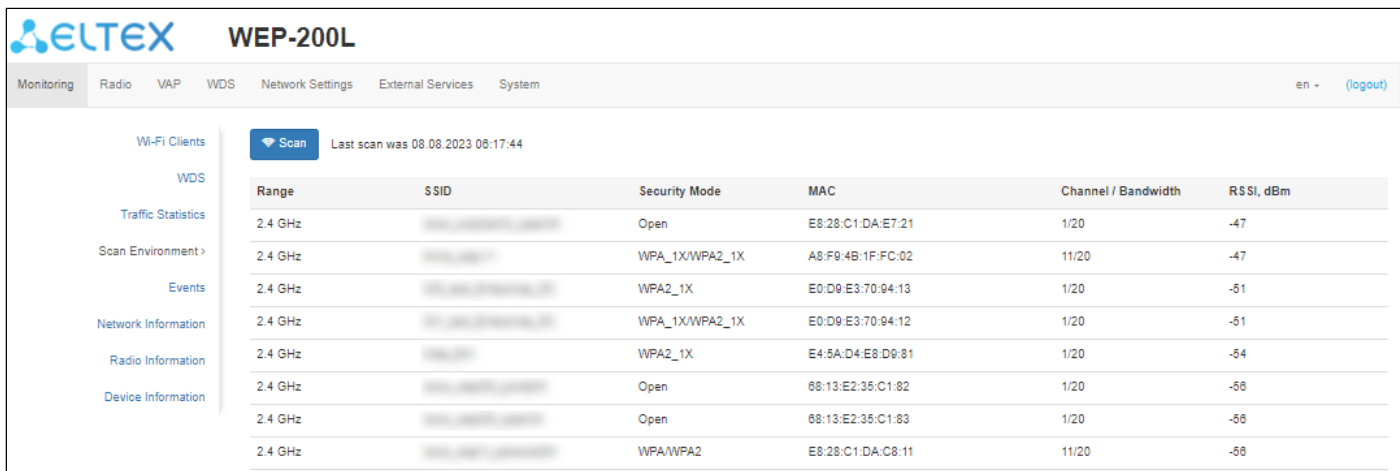

The screenshot shows the WEP-200L web interface. At the top, there is a navigation bar with tabs: Monitoring, Radio, VAP, WDS, Network Settings, External Services, and System. The 'Scan Environment' submenu is active, displaying a 'Scan' button and the text 'Last scan was 08.08.2023 08:17:44'. Below this is a table with the following columns: Range, SSID, Security Mode, MAC, Channel / Bandwidth, and RSSI, dBm. The table contains eight rows of detected access points.

Range	SSID	Security Mode	MAC	Channel / Bandwidth	RSSI, dBm
2.4 GHz	[blurred]	Open	E8:28:C1:DA:E7:21	1/20	-47
2.4 GHz	[blurred]	WPA_1X/WPA2_1X	A8:F9:4B:1F:FC:02	11/20	-47
2.4 GHz	[blurred]	WPA2_1X	E0:D9:E3:70:94:13	1/20	-51
2.4 GHz	[blurred]	WPA_1X/WPA2_1X	E0:D9:E3:70:94:12	1/20	-51
2.4 GHz	[blurred]	WPA2_1X	E4:5A:D4:E8:D9:81	1/20	-54
2.4 GHz	[blurred]	Open	68:13:E2:35:C1:82	1/20	-56
2.4 GHz	[blurred]	Open	68:13:E2:35:C1:83	1/20	-56
2.4 GHz	[blurred]	WPA/WPA2	E8:28:C1:DA:C8:11	11/20	-56

To start the scanning process, click the “Scan” button. After the scanning is completed, a list of detected access points and information about them will appear:

- *Last scan was...* – date and time of the last scanning;
- *Range* – specifies the range of 2.4 GHz or 5 GHz in which the access point was detected;
- *SSID* – SSID of the detected access point;
- *Security mode* – security mode of the detected access point;
- *MAC* – MAC address of the detected access point;
- *Channel/Bandwidth* – radio channel on which the detected access point operates;
- *RSSI* – the level with which the device receives the signal of the detected access point, dBm.

- ✓ While scanning the environment, the device radio interface will be disabled, which will make it impossible to transfer data to Wi-Fi clients during scanning.

### 5.4.5 The “Events” submenu

In the “**Events**” submenu, it is possible to view a list of real-time informational messages which contains the following information:

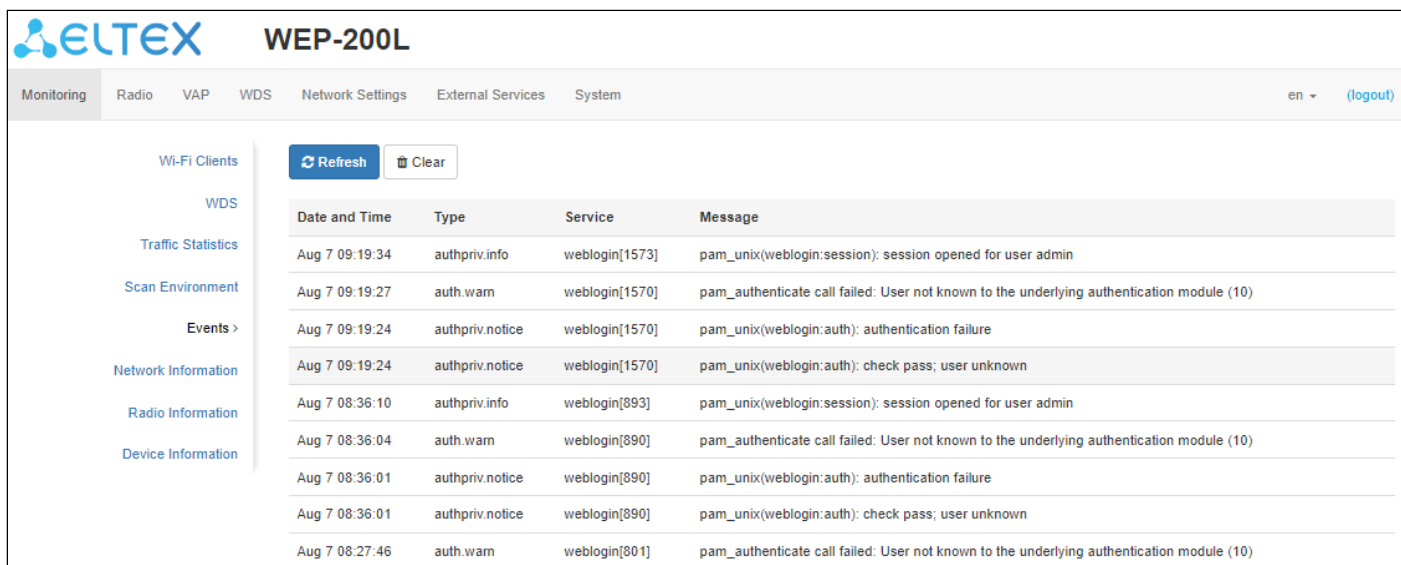

Date and Time	Type	Service	Message
Aug 7 09:19:34	authpriv.info	weblogin[1573]	pam_unix(weblogin:session): session opened for user admin
Aug 7 09:19:27	auth.warn	weblogin[1570]	pam_authenticate call failed: User not known to the underlying authentication module (10)
Aug 7 09:19:24	authpriv.notice	weblogin[1570]	pam_unix(weblogin:auth): authentication failure
Aug 7 09:19:24	authpriv.notice	weblogin[1570]	pam_unix(weblogin:auth): check pass; user unknown
Aug 7 08:36:10	authpriv.info	weblogin[893]	pam_unix(weblogin:session): session opened for user admin
Aug 7 08:36:04	auth.warn	weblogin[890]	pam_authenticate call failed: User not known to the underlying authentication module (10)
Aug 7 08:36:01	authpriv.notice	weblogin[890]	pam_unix(weblogin:auth): authentication failure
Aug 7 08:36:01	authpriv.notice	weblogin[890]	pam_unix(weblogin:auth): check pass; user unknown
Aug 7 08:27:46	auth.warn	weblogin[801]	pam_authenticate call failed: User not known to the underlying authentication module (10)

- *Date and Time* – date and time when the event was generated;
- *Type* – category and severity level of the event;
- *Service* – name of the process that generated the message;
- *Message* – event description.

Table 7 – Description of event severity levels

Level	Message severity level	Description
0	Emergency	A critical error has occurred in the system, the system may not work properly.
1	Alert	Immediate intervention is required.
2	Critical	A critical error has occurred in the system.
3	Error	An error has occurred in the system.
4	Warning	Warning, non-emergency message.
5	Notice	System notice, non-emergency message.
6	Informational	Informational system messages.
7	Debug	Debugging messages provide the user with information to correctly configure the system.

To receive new messages in the event log, click “Refresh”.

If necessary, all old messages can be deleted from the log by clicking “Clear”.

### 5.4.6 The “Network Information” submenu

In the “**Network Information**” submenu, general network settings of the device can be viewed.

The screenshot shows the ELTEX WEP-200L web interface. The top navigation bar includes Monitoring, Radio, VAP, WDS, Network Settings, External Services, and System. The left sidebar lists various menu items, with 'Network Information' expanded to show 'Radio Information' and 'Device Information'. The main content area displays the following sections:

- WAN Status:**
  - Interface: br0
  - Protocol: DHCP
  - IP Address: 10.24.80.94
  - RX Bytes: 4.5 MiB (4 705 956 bytes)
  - TX Bytes: 1.5 MiB (1 608 530 bytes)
- Ethernet:**
  - Link Status: Up
  - Speed: 1000
  - Duplex: Full
- ARP:**

#	IP Address	MAC
0	10.24.80.47	14:CC:20:05:A9:7E
1	10.24.80.1	E0:D9:E3:E8:E1:40
- Routes:**

#	Interface	Destination	Gateway	Netmask	Flags
0	br0	0.0.0.0	10.24.80.1	0.0.0.0	UG
1	br0	10.24.80.0	0.0.0.0	255.255.255.0	U

#### WAN Status:

- *Interface* – name of the bridge interface;
- *Protocol* – protocol used for access to WAN;
- *IP address* – device IP address in external network;
- *RX Bytes* – number of bytes received on WAN;
- *TX Bytes* – number of bytes sent from WAN.

#### Ethernet:

- *Link Status* – Ethernet port status;
- *Speed* – Ethernet port connection speed;
- *Duplex* – data transfer mode:
  - *Full* – full duplex;
  - *Half* – half-duplex.

#### ARP

The ARP table contains mapping information between the IP and MAC addresses of neighboring network devices:

- *IP address* – device IP address;
- *MAC* – device MAC address.

#### Routes:

- *Interface* – name of the bridge interface;
- *Destination* – IP address of destination host or subnet that the route is established to;
- *Gateway* – IP address of the gateway through which access to the destination is carried out;
- *Netmask* – subnet mask;
- *Flags* – certain route characteristics.

The following flag values exist:

- **U** – means that the route is created and passable;
- **H** – identifies the route to the specific host;
- **G** – means that the route lies through the external gateway. System network interface provides routes in the network with direct connection. All other routes lie through the external gateways. G flag is used for all routes except for the routes in the direct connection networks;
- **R** – indicates that the route was most likely created by a dynamic routing protocol running on the local system using the reinstate parameter;
- **D** – indicates that the route was added as a result of receiving an ICMP Redirect Message. When the system learns the route from the ICMP Redirect message, the route will be added into the routing table in order to exclude redirection for the following packets intended for the same destination;
- **M** – means that the route was modified – likely by a dynamic routing protocol running on a local system with the “mod” parameter applied;
- **A** – points to a buffered route to which an entry in the ARP table corresponds;
- **C** – means that the route source is the core routing buffer;
- **L** – indicates that the destination of the route is one of the addresses of this computer. Such “local routes” exist in the routing buffer only;
- **B** – means that the route destination is a broadcasting address. Such “broadcast routes” exist in the routing buffer only;
- **I** – indicates that the route is connected to a ring (loopback) interface for a purpose other than to access the ring network. Such “internal routes” exist in the routing buffer only;
- **!** – means that datagrams sent to this address will be rejected by the system.

### 5.4.7 The “Radio Information” submenu

In the “**Radio Information**” submenu, the current status of WEP-200L radio interfaces is displayed.

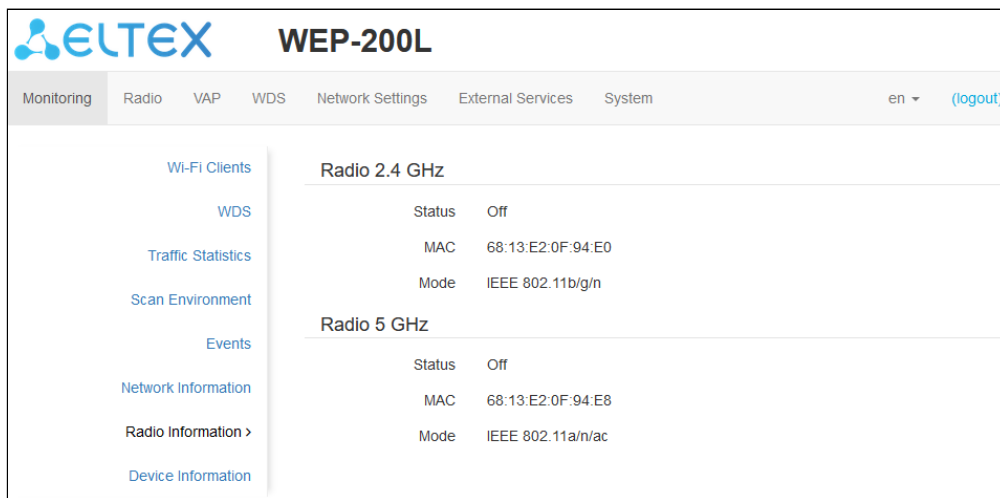

The access point radio interfaces can be in two states: “On” and “Off”. The status of each radio interface is shown in the “Status” field.

The Radio status depends on whether the radio interface has enabled virtual access points (VAPs) or WDS. In case there is at least one active VAP on the radio interface, Radio will be in “On” status, otherwise – “Off”.

Depending on the Radio status, the following information is available for monitoring:

#### “Off”:

- *Status* – radio interface state;
- *MAC* – radio interface MAC address;
- *Mode* – radio interface operation mode according to IEEE 802.11 standards.

#### “On”:

- *Status* – radio interface state;
- *MAC* – radio interface MAC address;
- *Mode* – radio interface operation mode according to IEEE 802.11 standards;
- *Channel* – number of the wireless channel on which the radio interface is running;
- *Channel bandwidth* – bandwidth of the channel on which the radio interface is running.

### 5.4.8 The “Device Information” submenu

The “**Device Information**” submenu displays WEP-200L main characteristics.

Parameter	Value
Product	WEP-200L
Hardware Version	1v1
Factory MAC Address	68:13:E2:0F:94:E0
Serial Number	[Redacted]
Software Version	[Redacted]
Backup Version	[Redacted]
Boot Version	[Redacted]
System Time	04/15/2024 13:42:20
Uptime	0 d, 00:00:50
CPU Usage	9%
Memory Usage	35% 84 MB / 237 MB

- *Product* – device model name;
- *Hardware Version* – device hardware version;
- *Factory MAC Address* – device WAN interface MAC address, factory set;
- *Serial Number* – device serial number, factory set;
- *Software Version* – device firmware version;
- *Backup Version* – previously installed firmware version;
- *Boot Version* – device firmware boot version;
- *System Time* – current time and date, set in the system;
- *Uptime* – operating time since the last time the device was turned on or rebooted;
- *CPU Usage* – average percentage of CPU load over the last 5 seconds;
- *Memory Usage* – percentage of device RAM usage.

## 5.5 The “Radio” menu

In the “**Radio**” menu, the wireless interface can be configured.

### 5.5.1 The “Radio 2.4 GHz” submenu

In the “**Radio 2.4 GHz**” submenu, the main parameters of the radio interface of the device operating in the 2.4 GHz band can be configured.

- *Mode* – interface operation mode according to the following standards:
  - IEEE 802.11n;
  - IEEE 802.11b/g;
  - IEEE 802.11b/g/n.
- *Auto Channel* – when checked, the device will automatically select the least congested radio channel for the Wi-Fi interface. Unchecking the flag opens the access to install the static operation channel;
- *Channel* – select channel for data transmission;
- *Use Limit Channels* – when checked, the access point will use a user-defined list of channels to work in automatic channel selection mode. If the “Use Limit channels” flag is not checked or there are no channels in the list, the access point will select the operation channel from all available channels in the given band. 2.4 GHz band channels: 1–13;
- *Channel Bandwidth, MHz* – channel bandwidth, on which the access point operates. The parameter may take values 20 and 40 MHz;
- *Primary Channel* – the parameter can only be changed if the bandwidth of a statically specified channel is equal to 40 MHz. The 40 MHz channel can be considered as consisting of two 20 MHz channels, which border in the frequency range. These two 20 MHz channels are called primary and secondary channels. The primary channel is used by clients supporting 20 MHz channel bandwidth only:
  - *Upper* – the primary channel will be the upper 20 MHz channel in the 40 MHz band;
  - *Lower* – the primary channel will be the lower 20 MHz channel in the 40 MHz band.
- *Transmit Power Limit, dBm* – adjustment of the signal strength of the Wi-Fi transmitter in dBm. Accepts value from 4 to 16 dBm.



- ✓ If the “Use Limit channels” list contains a channel that is not available for selection, it will be marked in grey. In order for the new configuration to be applied to an access point, only available (blue highlighted) channels must be specified in the “Use Limit channels” list.

**Example.** No settings have been made on the access point yet, Radio 2.4 GHz is set to 20 MHz “Channel Bandwidth” by default, and channels are specified in the “Use Limit channels” list: 1, 6, 11. Suppose the parameter “Channel Bandwidth” should be set to 40 MHz. Upon changing this parameter from 20 MHz to 40 MHz, the following happens:

- the “Primary Channel” parameter becomes available for editing and the default value is “Lower”;
- channel 11 in the “Use Limit channels” list changes its color from blue to grey.

If to change the “Channel Bandwidth” parameter to 40 MHz and do not remove the “grey” channels from the list, then when clicking “Apply”, in the browser an error will appear – “There are errors in data. Changes were not applied”. Accordingly, the access point configuration will not be changed. This is due to the fact that channels in the “Use Limit channels” list that are highlighted in grey do not fit the definition “Primary Channel” = Lower.

In the “Advanced” section, it is possible to configure advanced radio interface parameters of the device.

Advanced ▾

Fixed Transmit Rate: Auto ▾

Short Guard Interval:

STBC:

Beacon Interval, ms: 100

Fragmentation Threshold: 2346

RTS Threshold: 2347

Frame Aggregation:

Short Preamble:

Broadcast/Multicast Rate Limiting, p/s:

Wi-Fi Multimedia (WMM):

DHCP Snooping Mode: replace ▾

DHCP Option 82 CID Format: APMAC-SSID ▾

DHCP Option 82 RID Format: ClientMAC ▾

DHCP Option 82 MAC Format: AA:BB:CC:DD:EE:FF ▾

Enable QoS:

- *OBSS Coexistence* – automatic channel bandwidth reduction when the channel is loaded. When the flag is set, the mode is enabled;
- *Fixed Transmit Rate* – fixed wireless data rate, defined by IEEE 802.11b/g/n specifications;
- *Short Guard Interval* – support for Short Guard Interval. Access point transmits data using 400 ns guard interval (instead of 800 ns) to clients which also support Short Guard Interval;

- *STBC* – Space-Time Block Coding method dedicated to improve data transmission reliability. The field is available only if the selected operating mode for the radio interface includes 802.11n. When checked, the device transmits one data flow through several antennas. When unchecked, the device does not transmit the same data flow through several antennas;
- *Beacon Interval, ms* – beacon frames transmission period. The frames are sent to detect access points on the air. The parameter takes values from 20 to 2000 ms, by default: 100 ms;
- *Fragmentation Threshold* – frame fragmentation threshold, bytes. The parameter takes values 256–2346, by default: 2346;
- *RTS Threshold* – specifies the number of bytes over which the Request to Send will be sent. Decreasing this value may improve the performance of the access point when there are a lot of connected clients. However this reduces general throughput of wireless network. The parameter takes values from 0 to 2347, by default: 2347;
- *Frame aggregation* – enable support for AMPDU/AMSDU;
- *Short Preamble* – use of the packet short preamble;
- *Broadcast/Multicast Rate Limiting, p/s* – when the flag is set, transmission of broadcast / multicast traffic over the wireless network is restricted. Specify the limit for broadcast traffic in the popup window (p/s);
- *Wi-Fi Multimedia (WMM)* – WMM support activation (Wi-Fi Multimedia);
- *DHCP Snooping Mode* – selection of DHCP option 82 processing policy. Available values for selection:
  - *ignore* – option 82 processing is disabled. Default value;
  - *remove* – access point deletes the value of option 82;
  - *replace* – access point substitutes or replaces the value of option 82. When selecting this value to edit, the following parameters are opened:
    - *DHCP Option 82 CID Format* – replacement of the CID parameter value, can take values:
      - *APMAC-SSID* – replacement of the CID parameter value to <MAC address of the access point>-<SSID name>. Default value;
      - *SSID* – replacement of the CID parameter value to SSID name, to which the client is connected;
      - *custom* – replacement of the CID parameter value to the value specified in the "Option 82 Unique CID";
        - *Option 82 Unique CID* – an arbitrary string of up to 52 characters that will be passed to the CID. If the parameter value is not set, the point will change the CID to the default value – APMAC-SSID.
    - *DHCP Option 82 RID Format* – replacement of the RID parameter value, can take the following values:
      - *ClientMAC* – change the RID content to the MAC address of the client device. Default value;
      - *APMAC* – change the RID content to the MAC address of the access point;
      - *APdomain* – change the RID content to the domain in which the access point is located;
      - *custom* – change the RID content to the value specified in the "Option 82 Unique RID";
        - *Option 82 Unique RID* – an arbitrary string of up to 63 characters that will be passed to the RID. If the parameter value is not set, the point will change the RID to the default value – ClientMAC.
    - *DHCP Option 82 MAC Format* – selection of octet delimiters of the MAC address, which is transmitted in CID and RID:
      - *AA:BB:CC:DD:EE:FF* – the delimiter is a colon (:). Default value;
      - *AA-BB-CC-DD-EE-FF* – the delimiter is a dash (-).
- *Enable QoS* – when the flag is set, the setting of Quality of Service functions is available.

The following functions are available for quality assurance configuration:

AP EDCA Parameters				
Queue	AIFS	cwMin	cwMax	TXOP Limit
Data 3 (Background)	<input type="text" value="7"/>	<input type="text" value="15"/> ▾	<input type="text" value="1023"/> ▾	<input type="text" value="0"/>
Data 2 (Best Effort)	<input type="text" value="3"/>	<input type="text" value="15"/> ▾	<input type="text" value="63"/> ▾	<input type="text" value="0"/>
Data 1 (Video)	<input type="text" value="1"/>	<input type="text" value="7"/> ▾	<input type="text" value="15"/> ▾	<input type="text" value="94"/>
Data 0 (Voice)	<input type="text" value="1"/>	<input type="text" value="3"/> ▾	<input type="text" value="7"/> ▾	<input type="text" value="47"/>
Station EDCA Parameters				
Queue	AIFS	cwMin	cwMax	TXOP Limit
Data 3 (Background)	<input type="text" value="7"/>	<input type="text" value="15"/> ▾	<input type="text" value="1023"/> ▾	<input type="text" value="0"/>
Data 2 (Best Effort)	<input type="text" value="3"/>	<input type="text" value="15"/> ▾	<input type="text" value="1023"/> ▾	<input type="text" value="0"/>
Data 1 (Video)	<input type="text" value="2"/>	<input type="text" value="7"/> ▾	<input type="text" value="15"/> ▾	<input type="text" value="94"/>
Data 0 (Voice)	<input type="text" value="2"/>	<input type="text" value="3"/> ▾	<input type="text" value="7"/> ▾	<input type="text" value="47"/>

- *AP EDCA parameters* – access point settings table (traffic is transmitted from the access point to the client):
  - *Queue* – predefined queues for various kinds of traffic:
    - *Data 3 (Background)* – low priority queue, high bandwidth (802.1p: cs1, cs2 priorities);
    - *Data 2 (Best Effort)* – middle priority queue, middle bandwidth and delay. Most of the traditional IP data is sent to this queue (802.1p: cs0, cs3 priorities);
    - *Data 1 (Video)* – high priority queue, minimal delay. In this queue, time-sensitive video data is automatically processed (802.1p: cs4, cs5 priorities);
    - *Data 0 (Voice)* – high priority queue, minimal delay. In this queue, time sensitive data is automatically processed, such as: VoIP, streaming video (802.1p: cs6, cs7 priorities).
  - *AIFS* – Arbitration Inter-Frame Spacing, defines the waiting time of data frames, measured in slots, takes values 1–255;
  - *cwMin* – the initial timeout value before resending a frame, specified in milliseconds, takes the values 1, 3, 7, 15, 31, 63, 127, 255, 511, 1023. The value of cwMin cannot exceed the value of cwMax;
  - *cwMax* – the maximum timeout value before resending a frame, specified in milliseconds, takes the values 1, 3, 7, 15, 31, 63, 127, 255, 511, 1023. The value of cwMax must exceed the value of cwMin;
  - *TXOP Limit* – this parameter is used only for data transmitted from the client station to the access point. The transmission capability is the time interval, in milliseconds, when the client WME station has the rights to initiate data transmission over the wireless medium to the access point, the maximum value is 65535 milliseconds.
- *Station EDCA parameters* – table of client station parameter settings (traffic is transmitted from the client station to the access point). For description of table fields, see above.

To apply a new configuration and save settings to non-volatile memory, click “Apply”. Click “Cancel” to discard the changes.

## 5.5.2 The “Radio 5 GHz” submenu

In the “**Radio 5 GHz**” submenu, the main parameters of the radio interface of the device operating in the 5 GHz band can be configured.

The screenshot shows the configuration page for the WEP-200L device, specifically the 'Radio 5 GHz' submenu. The page is titled 'WEP-200L' and has a navigation menu with 'Radio' selected. The 'Radio 5 GHz' submenu is active, showing 'Common' settings. The 'Mode' is set to 'IEEE 802.11a/n/ac'. 'Auto Channel' and 'Use Limit Channels' are checked. A list of channels is shown: 36 (5170 — 5210 MHz), 40 (5170 — 5210 MHz), 44 (5210 — 5250 MHz), and 48 (5210 — 5250 MHz). 'Channel Bandwidth, MHz' is set to 40, 'Primary Channel' is set to 'Upper', and 'Transmit Power Limit, dBm' is set to 19. There are 'Apply' and 'Cancel' buttons at the bottom.

- *Mode* – select interface operation mode according to the following standards:
  - IEEE 802.11a;
  - IEEE 802.11a/n;
  - IEEE 802.11a/n/ac.
- *Auto Channel* – when checked, the device will automatically select the least congested radio channel for the Wi-Fi interface. Removing the flag opens the access to install the static operation channel;
- *Channel* – select channel for data transmission;
- *Use Limit Channels* – when checked, the access point will use a user-defined list of channels to work in automatic channel selection mode. If the “Use Limit channels” flag is not checked or there are no channels in the list, the access point will select the operation channel from all available channels in the given band. 5 GHz band channels: 36–64, 132–144, 149–165;
- *Channel Bandwidth, MHz* – channel bandwidth, on which the access point operates. The parameter may take values of 20, 40 and 80 MHz;
- *Primary Channel* – the parameter can only be changed if the bandwidth of a statically specified channel is equal to 40 MHz. The 40 MHz channel can be considered as consisting of two 20 MHz channels, which border in the frequency range. These two 20 MHz channels are called primary and secondary channels. The primary channel is used by clients who only support 20 MHz channel bandwidth:
  - *Upper* – the primary channel will be the upper 20 MHz channel in the 40 MHz band;
  - *Lower* – the primary channel will be the lower 20 MHz channel in the 40 MHz band.
- *Transmission Power Limit, dBm* – transmitting Wi-Fi signal power adjustment, dBm. May take values between 8 and 19 dBm.

- ✓ If the “Use Limit channels” list contains a channel that is not available for selection, it will be marked in grey. In order for the new configuration to be applied to an access point, only available (blue highlighted) channels must be specified in the “Use Limit channels” list.

**Example.** No settings have been made on the access point yet, Radio 5 GHz is set to 20 MHz “Channel Bandwidth” by default, and channels are specified in the “Use Limit channels” list: 36, 40, 44, 48.

Suppose, it is required to set “Channel Bandwidth” to 40 MHz. When you change this parameter from 20 MHz to 40 MHz, the following happens:

- the “Primary Channel” parameter becomes available for editing and the default value is “Upper”;
- channels 36 and 44 in the “Use Limit channels” list changes its color from blue to grey.

If you change the “Channel Bandwidth” parameter to 40 MHz and do not remove the “grey” channels from the list, then when you click “Apply” in the browser an error will appear – “There are errors in data. Changes were not applied”. Accordingly, the access point configuration will not be changed. This is due to the fact that channels in the “Use Limit channels” list that are highlighted in grey do not fit the definition “Primary Channel” = Upper.

In the “Advanced” section, it is possible to configure advanced radio interface parameters of the device.

The screenshot shows the 'Advanced' configuration page for a radio interface. The settings are as follows:

- OBSS Coexistence:
- Fixed Transmit Rate: Auto (dropdown)
- DFS Support: Forced (dropdown)
- Short Guard Interval:
- STBC:
- Beacon Interval, ms: 100 (text input)
- Fragmentation Threshold: 2346 (text input)
- RTS Threshold: 2347 (text input)
- Frame Aggregation:
- Short Preamble:
- Broadcast/Multicast Rate Limiting, p/s:
- Wi-Fi Multimedia (WMM):
- DHCP Snooping Mode: replace (dropdown)
- DHCP Option 82 CID Format: APMAC-SSID (dropdown)
- DHCP Option 82 RID Format: ClientMAC (dropdown)
- DHCP Option 82 MAC Format: AA:BB:CC:DD:EE:FF (dropdown)
- Enable QoS:

At the bottom, there are two buttons: 'Apply' (with a checkmark icon) and 'Cancel' (with an 'x' icon).

- *OBSS Coexistence* – automatic channel bandwidth reduction when the channel is loaded. When the flag is set, the mode is enabled;
- *Fixed Transmit Rate* – fixed wireless data rate, defined by IEEE 802.11b/g/n specifications;
- *DFS Support* – dynamic frequency selection mechanism. The mechanism demands wireless devices to scan environment and avoid using channels which coincide with radiolocation system’s channels at 5 GHz:

- *Disabled* – the mechanism is disabled. DFS channels are not available for selection;
- *Enabled* – the mechanism is enabled;
- *Forced* – the mechanism is disabled. DFS channels are available for selection.
- *Short Guard Interval* – support for Short Guard Interval. Access point transmits data using 400 ns guard interval (instead of 800 ns) to clients which also support Short Guard Interval;
- *STBC* – Space-Time Block Coding method dedicated to improve data transmission reliability. The field is available only if the selected operating mode for the radio interface includes 802.11n. When checked, the device transmits one data flow through several antennas. When unchecked, the device does not transmit the same data flow through several antennas;
- *Beacon Interval, ms* – beacon frames transmission period. The frames are sent to detect access points. The parameter takes values from 20 to 2000 ms, by default: 100 ms;
- *Fragmentation Threshold* – frame fragmentation threshold, bytes. The parameter takes values 256–2346, by default: 2346;
- *RTS Threshold* – specifies the number of bytes over which the Request to Send will be sent. Decreasing this value may improve the performance of the access point when there are a lot of connected clients. However this reduces general throughput of wireless network. The parameter takes values from 0 to 2347, by default: 2347;
- *Frame aggregation* – enables support for AMPDU/AMSDU;
- *Short Preamble* – use of the packet short preamble;
- *Broadcast/Multicast Rate Limiting, p/s* – when the flag is set, transmission of broadcast / multicast traffic over the wireless network is restricted. Specify the limit for broadcast traffic in the popup window (p/s);
- *Wi-Fi Multimedia (WMM)* – WMM support activation (Wi-Fi Multimedia);
- *DHCP Snooping Mode* – selection of DHCP option 82 processing policy. Available values for selection:
  - *ignore* – option 82 processing is disabled. Default value;
  - *remove* – access point deletes the value of option 82;
  - *replace* – access point substitutes or replaces the value of option 82. When selecting this value to edit, the following parameters are opened:
    - *DHCP Option 82 CID Format* – replacement of the CID parameter value, can take values:
      - *APMAC-SSID* – replacement of the CID parameter value to <MAC address of the access point>-<SSID name>. Default value;
      - *SSID* – replacement of the CID parameter value to SSID name, to which the client is connected;
      - *custom* – replacement of the CID parameter value to the value specified in the "Option 82 Unique CID";
        - *Option 82 Unique CID* – an arbitrary string of up to 52 characters that will be passed to the CID. If the parameter value is not set, the point will change the CID to the default value – APMAC-SSID.
    - *DHCP Option 82 RID Format* – replacement of the RID parameter value, can take the following values:
      - *ClientMAC* – change the RID content to the MAC address of the client device. Default value;
      - *APMAC* – change the RID content to the MAC address of the access point;
      - *APdomain* – change the RID content to the domain in which the access point is located;
      - *custom* – change the RID content to the value specified in the "Option 82 Unique RID";
        - *Option 82 Unique RID* – an arbitrary string of up to 63 characters that will be passed to the RID. If the parameter value is not set, the point will change the RID to the default value – ClientMAC.
    - *DHCP Option 82 MAC format* – selection of octet delimiters of the MAC address, which is transmitted in CID and RID:
      - *AA:BB:CC:DD:EE:FF* – the delimiter is a colon (:). Default value;
      - *AA-BB-CC-DD-EE-FF* – the delimiter is a dash (-).
- *Enable QoS* – when the flag is set, the setting of Quality of Service functions is available.

The following functions are available for quality assurance configuration:

AP EDCA Parameters				
Queue	AIFS	cwMin	cwMax	TXOP Limit
Data 3 (Background)	<input type="text" value="7"/>	<input type="text" value="15"/> ▼	<input type="text" value="1023"/> ▼	<input type="text" value="0"/>
Data 2 (Best Effort)	<input type="text" value="3"/>	<input type="text" value="15"/> ▼	<input type="text" value="63"/> ▼	<input type="text" value="0"/>
Data 1 (Video)	<input type="text" value="1"/>	<input type="text" value="7"/> ▼	<input type="text" value="15"/> ▼	<input type="text" value="94"/>
Data 0 (Voice)	<input type="text" value="1"/>	<input type="text" value="3"/> ▼	<input type="text" value="7"/> ▼	<input type="text" value="47"/>
Station EDCA Parameters				
Queue	AIFS	cwMin	cwMax	TXOP Limit
Data 3 (Background)	<input type="text" value="7"/>	<input type="text" value="15"/> ▼	<input type="text" value="1023"/> ▼	<input type="text" value="0"/>
Data 2 (Best Effort)	<input type="text" value="3"/>	<input type="text" value="15"/> ▼	<input type="text" value="1023"/> ▼	<input type="text" value="0"/>
Data 1 (Video)	<input type="text" value="2"/>	<input type="text" value="7"/> ▼	<input type="text" value="15"/> ▼	<input type="text" value="94"/>
Data 0 (Voice)	<input type="text" value="2"/>	<input type="text" value="3"/> ▼	<input type="text" value="7"/> ▼	<input type="text" value="47"/>

- *AP EDCA parameters* – access point settings table (traffic is transmitted from the access point to the client):
  - *Queue* – predefined queues for various kinds of traffic:
    - *Data 3 (Background)* – low priority queue, high bandwidth (802.1p: cs1, cs2 priorities);
    - *Data 2 (Best Effort)* – middle priority queue, middle bandwidth and delay. Most of the traditional IP data is sent to this queue (802.1p: cs0, cs3 priorities);
    - *Data 1 (Video)* – high priority queue, minimal delay. In this queue, time-sensitive video data is automatically processed (802.1p: cs4, cs5 priorities);
    - *Data 0 (Voice)* – high priority queue, minimal delay. In this queue, time sensitive data is automatically processed, such as: VoIP, streaming video (802.1p: cs6, cs7 priorities).
  - *AIFS* – Arbitration Inter-Frame Spacing, defines the waiting time of data frames, measured in slots, takes values 1–255;
  - *cwMin* – the initial timeout value before resending a frame, specified in milliseconds, takes the values 1, 3, 7, 15, 31, 63, 127, 255, 511, 1023. The value of cwMin cannot exceed the value of cwMax;
  - *cwMax* – the maximum timeout value before resending a frame, specified in milliseconds, takes the values 1, 3, 7, 15, 31, 63, 127, 255, 511, 1023. The value of cwMax must exceed the value of cwMin;
  - *TXOP Limit* – this parameter is used only for data transmitted from the client station to the access point. The transmission capability is the time interval, in milliseconds, when the client WME station has the rights to initiate data transmission over the wireless medium to the access point, the maximum value is 65535 milliseconds.
- *Station EDCA parameters* – table of client station parameter settings (traffic is transmitted from the client station to the access point). For description of table fields, see above.

To apply a new configuration and save settings to non-volatile memory, click “Apply”. Click “Cancel” to discard the changes.

### 5.5.3 The “Advanced” submenu

In the “**Advanced**” submenu, it is possible to configure advanced radio interface parameters of the device.

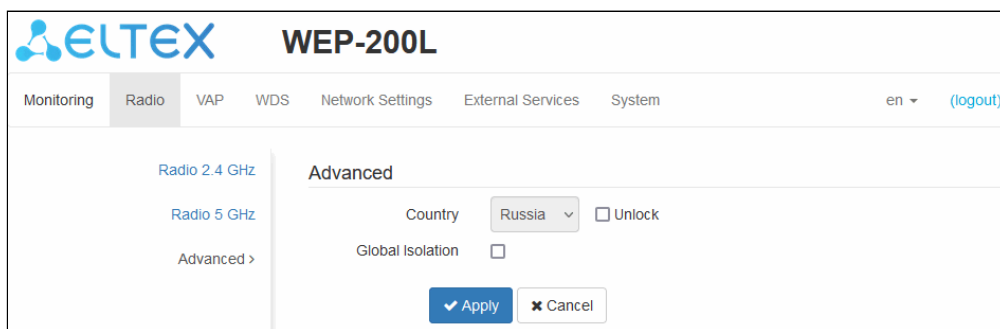

- *Country* – country of access point operation. Select the “Unlock” checkbox to change a country. Depending on the selected value the channel bandwidth and transmit power limit restrictions will be applied. The list of available frequency channels depends on the selected country, which affects the automatic channel selection in the Channel = Auto mode. If the subscriber equipment is licensed for use in a different region, probably, a connection with the access point will not be established.

⚠ Local country regulations settings, including operation within legal frequency channels and output power, is the installer's responsibility.

✔ Selecting the wrong region may result in compatibility issues with different client devices.

- *Global Isolation* – when checked, traffic isolation between clients of different VAPs and different radio interfaces is enabled.

To apply a new configuration and save settings to non-volatile memory, click “Apply”. Click “Cancel” to discard the changes.



## 5.6 The “VAP” menu

In the “**VAP**” menu, virtual Wi-Fi access points (VAP) can be configured.

### 5.6.1 The “Summary” submenu

The “**Summary**” submenu displays the settings of all VAPs on Radio 2.4 GHz and Radio 5 GHz radio interfaces. The settings of each virtual access point can be viewed in sections of VAP0–VAP6.

The screenshot shows the WEP-200L configuration interface. The top navigation bar includes 'Monitoring', 'Radio', 'VAP', 'WDS', 'Network Settings', 'External Services', and 'System'. The 'VAP' menu is selected. Below the navigation bar, there are tabs for '2.4 GHz' and '5 GHz'. The '2.4 GHz' tab is active. On the left, there is a 'Summary >' sidebar with '2.4 GHz' and '5 GHz' options. The main area displays a table of VAP settings for 2.4 GHz. At the bottom, there are 'Apply' and 'Cancel' buttons.

VAP	Enabled	Security Mode	VLAN ID	SSID	Broadcast SSID	Band Steer	VLAN Trunk	General Mode	General VLAN ID	Station Isolation
VAP0	<input type="checkbox"/>	Off	<input type="text"/>	WEP-200L_2.4GHz	<input checked="" type="checkbox"/>	<input type="checkbox"/>	<input type="checkbox"/>	<input type="checkbox"/>	<input type="text"/>	<input type="checkbox"/>
VAP1	<input type="checkbox"/>	Off	<input type="text"/>	WEP-200L_2.4GHz-1	<input checked="" type="checkbox"/>	<input type="checkbox"/>	<input type="checkbox"/>	<input type="checkbox"/>	<input type="text"/>	<input type="checkbox"/>
VAP2	<input type="checkbox"/>	Off	<input type="text"/>	WEP-200L_2.4GHz-2	<input checked="" type="checkbox"/>	<input type="checkbox"/>	<input type="checkbox"/>	<input type="checkbox"/>	<input type="text"/>	<input type="checkbox"/>
VAP3	<input type="checkbox"/>	Off	<input type="text"/>	WEP-200L_2.4GHz-3	<input checked="" type="checkbox"/>	<input type="checkbox"/>	<input type="checkbox"/>	<input type="checkbox"/>	<input type="text"/>	<input type="checkbox"/>
VAP4	<input type="checkbox"/>	Off	<input type="text"/>	WEP-200L_2.4GHz-4	<input checked="" type="checkbox"/>	<input type="checkbox"/>	<input type="checkbox"/>	<input type="checkbox"/>	<input type="text"/>	<input type="checkbox"/>
VAP5	<input type="checkbox"/>	Off	<input type="text"/>	WEP-200L_2.4GHz-5	<input checked="" type="checkbox"/>	<input type="checkbox"/>	<input type="checkbox"/>	<input type="checkbox"/>	<input type="text"/>	<input type="checkbox"/>
VAP6	<input type="checkbox"/>	Off	<input type="text"/>	WEP-200L_2.4GHz-6	<input checked="" type="checkbox"/>	<input type="checkbox"/>	<input type="checkbox"/>	<input type="checkbox"/>	<input type="text"/>	<input type="checkbox"/>

- *VAP0–VAP6* – the sequence number of the virtual access point;
- *Enabled* – when checked, the virtual access point is enabled, otherwise it is disabled;
- *Security Mode* – the type of data encryption used on the virtual access point;
- *VLAN ID* – VLAN number from which the tag will be removed when transmitting Wi-Fi traffic to clients connected to this VAP. When traffic flows in the opposite direction, untagged traffic from clients will be tagged with VLAN ID (when VLAN Trunk mode is disabled);
- *SSID* – virtual wireless network name;
- *Broadcast SSID* – when checked, SSID broadcasting is on, otherwise it is disabled;
- *Band Steer* – when the flag is set, the priority connection of the client to 5 GHz network is active. In order for this feature to work, it is required to create a VAP with the same SSID on each radio interface and activate the “Band Steer mode” on them;
- *VLAN Trunk* – when the flag is set, tagged traffic is transmitted to the subscriber;
- *General Mode* – when the flag is set, transmission of untagged traffic jointly with tagged traffic is allowed (available when Trunk VLAN mode is enabled);
- *General VLAN ID* – a tag will be removed from the specified VLAN ID and the traffic of this VLAN will pass to the client without a tag. When traffic passes in the opposite direction, untagged traffic will be tagged with General VLAN ID;
- *Station Isolation* – when checked, traffic isolation between clients in the same VAP is enabled.

To apply a new configuration and save settings to non-volatile memory, click “Apply”. Click “Cancel” to discard the changes.

## 5.6.2 The “VAP” submenu

The screenshot shows the WEP-200L web interface. The top navigation bar includes 'Monitoring', 'Radio', 'VAP', 'WDS', 'Network Settings', 'External Services', and 'System'. The 'VAP' tab is active, and the 'Common Settings' section is expanded. The settings are as follows:

- Enabled:
- VLAN ID:
- SSID: WEP-200L\_2.4GHz
- Broadcast SSID:
- Band Steer:
- VLAN Trunk:
- General Mode:
- Station Isolation:
- 802.11k/v:
- Wireless Multicast Forwarding:
- Priority: DSCP
- Maximum Stations: 0
- Minimal Signal: -100
- Security Mode: WPA2
- WPA Key: \*\*\*\*\*
- MFP: Not Required

### Common settings

- *Enabled* – when checked, the virtual access point is enabled, otherwise it is disabled;
- *VLAN ID* – VLAN number from which the tag will be removed when transmitting Wi-Fi traffic to clients connected to this VAP. When traffic flows in the opposite direction, untagged traffic from clients will be tagged with VLAN ID (when VLAN Trunk mode is disabled);
- *SSID* – virtual wireless network name;
- *Broadcast SSID* – when checked, SSID broadcasting is on, otherwise it is disabled;
- *Band Steer* – when the flag is set, the priority connection of the client to 5 GHz network is active. In order for this feature to work, it is required to create a VAP with the same SSID on each radio interface and activate the “Band Steer mode” on them;
- *VLAN Trunk* – when the flag is set, tagged traffic is transmitted to the subscriber;
- *General Mode* – when the flag is set, transmission of untagged traffic jointly with tagged traffic is allowed (available when Trunk VLAN mode is enabled);
- *General VLAN ID* – a tag will be removed from the specified VLAN ID and the traffic of this VLAN will pass to the client without a tag. When traffic passes in the opposite direction, untagged traffic will be tagged with General VLAN ID;
- *Station Isolation* – when checked, traffic isolation between clients in the same VAP is enabled;
- *802.11k/v* – enable support for 802.11k/v standards on virtual access point;
- *Wireless Multicast Forwarding* – when the flag is set, traffic towards clients will be converted to Unicast before each client, if it is disabled, it will pass without modifications;
- *Priority* – select prioritization mode. Defines the field on the basis of which the traffic transmitted to the radio interface will be distributed in WMM queues:
  - *DSCP* – will analyze the priority from the DSCP field of the IP packet header;
  - *802.1p* – will analyze the priority from the CoS (Class of Service) field of the tagged packets.

- *Minimal signal* – when the checkbox is selected, the function of disabling client Wi-Fi equipment when the signal level is low (*Minimal Signal Level*) is enabled. It is necessary to configure the following parameters:
  - *Minimal Signal Level, dBm* – signal level in dBm below which the client equipment is disconnected from the virtual network;
  - *Roaming Signal Level, dBm* – roaming sensitivity level in dBm, below which the client equipment switches to another access point. The parameter must be higher than the *Minimal Signal Level*: if the *Minimal Signal Level* is -75 dBm, then the *Roaming Signal Level* should be equal to, for example, -70 dBm;
  - *Minimal Signal Timeout, s* – the period of time after which a decision is made to disconnect client equipment from the virtual network.
- *Maximum Stations* – the maximum allowable number of clients connected to the virtual network;
- *MFP* – management frame protection (available for WPA2 and WPA2-Enterprise selected security mode, selecting other security modes puts the MFP in the disabled state):
  - *Not required* – management frame protection is disabled;
  - *Capable* – protection works if the client supports MFP. Clients without MFP support can connect to this VAP;
  - *Required* – management frame protection is enabled, clients that do not support MFP cannot connect.
- *Security Mode* – wireless access security mode:
  - *Off* – do not use encryption for data transfer. The access point is available for any subscriber to connect;
  - *WPA, WPA2, WPA/WPA2* – encryption methods, if you select one of the methods, the following setting will be available:
    - *WPA Key* – key/password required to connect to the virtual access point. The length of the key is from 8 to 63 characters.
  - *WPA-Enterprise, WPA2-Enterprise, WPA/WPA2-Enterprise* – wireless channel encryption mode, in which the client is authorized on the centralized RADIUS server. To configure this security mode, specify the parameters of the RADIUS server. Also specify a key for the RADIUS server. When selecting one of the these methods, the following setting will be available:

RADIUS	
Domain	<input type="text" value="root"/>
IP Address of RADIUS Server	<input type="text" value="192.168.0.1"/>
Port of RADIUS Server	<input type="text" value="1812"/>
Password of RADIUS Server	<input type="password" value="•••••"/>
Use Accounting through RADIUS	<input checked="" type="checkbox"/>
Use Other Settings For Accounting	<input checked="" type="checkbox"/>
IP Address of RADIUS Server for Accounting	<input type="text" value="192.168.0.1"/>
Port of RADIUS Server for Accounting	<input type="text" value="1813"/>
Password of RADIUS Server for Accounting	<input type="password" value="•••••"/>
Use Periodic Accounting	<input checked="" type="checkbox"/>
Accounting Interval	<input type="text" value="600"/>

- *Domain* – user domain;
- *IP Address of RADIUS Server* – RADIUS server address;
- *Port of RADIUS Server* – port of the RADIUS server that used for authentication and authorization;

- *Password of RADIUS Server* – password for the RADIUS server used for authentication and authorization;
- *Use Accounting through RADIUS* – when checked, “Accounting” messages will be sent to the RADIUS server;
- *Use Other Settings For Accounting*:
  - *IP Address of RADIUS Server for Accounting* – address of the RADIUS server, used for accounting;
  - *Password of RADIUS Server for Accounting* – password for the RADIUS server used for accounting.
- *Port of RADIUS Server for Accounting* – port that will be used to collect accounts on the RADIUS server;
- *Use Periodic Accounting* – enable periodic sending of “Accounting” messages to the RADIUS server. The interval for sending messages can be set in the “Accounting Interval” field.

### Captive Portal

Enable

Virtual Portal Name

Redirect URL

---

### RADIUS

Use Accounting through RADIUS

Domain

IP Address of RADIUS Server for Accounting

Port of RADIUS Server for Accounting

Password of RADIUS Server for Accounting

Use Periodic Accounting

Accounting Interval

---

### Shapers

Enable

VAP Limit Down   kbps

VAP Limit Up   kbps

STA Limit Down   kbps

STA Limit Up   kbps

### Captive Portal

When selecting one of the following security modes: Off, WPA, WPA2, WPA/WPA2, a portal authorization setting is available on the VAP.

- *Enable* – when checked, authorization of users in the network will be performed via the virtual portal;
- *Virtual Portal Name* – name of the virtual portal to which the user will be redirected when connecting to the network;
- *Redirect URL* – the address of the external virtual portal to which the user will be redirected when connecting to the network.

**RADIUS**

- *Use Accounting through RADIUS* – when checked, “Accounting” messages will be sent to the RADIUS server;
- *Domain* – user domain;
- *IP Address of RADIUS Server for Accounting* – address of the RADIUS server, used for accounting;
- *Port of RADIUS Server for Accounting* – port that will be used to collect accounts on the RADIUS server;
- *Password of RADIUS Server for Accounting* – password for the RADIUS server used for accounting;
- *Use Periodic Accounting* – enable periodic sending of “Accounting” messages to the RADIUS server. The interval for sending messages can be set in the “Accounting Interval” field.

**Shapers**



- *Enable* – activate the setting field;
- *VAP Limit Down* – restriction of bandwidth in the direction from the access point to the clients (in total) connected to this VAP, Kbps;
- *VAP Limit Up* – restriction of bandwidth in the direction from the clients (in total) connected to this VAP, to the access point, Kbps;
- *STA Limit Down* – restriction of bandwidth in the direction from the access point to the clients (each separately) connected to this VAP, Kbps;
- *STA Limit Up* – restriction of bandwidth in the direction from the clients (each separately) connected to this VAP, to the access point, Kbps.

**MAC ACL**

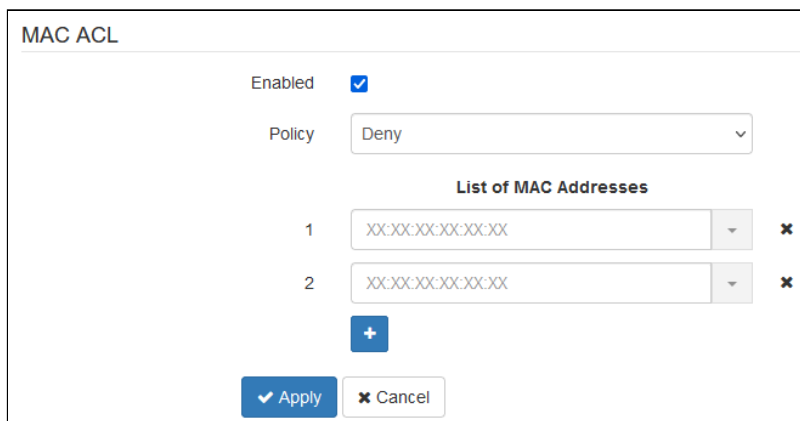
This subsection configures lists of MAC addresses of clients who, depending on the selected access policy, are allowed or denied to connect to this VAP.



- *Enabled* – when the checkbox is selected the chosen policy is active;
  - *Policy* – access policy. Available options:
    - *Deny* – specified MAC addresses will be denied to connect to this VAP. The access will be allowed for everyone else;
    - *Allow* – specified MAC addresses will be allowed to connect to this VAP. The access will be denied for everyone else.
  - *List of MAC Addresses* – a list of MAC addresses of clients who are allowed or denied access to this VAP. Can contain up to 128 addresses.

To add an address to the list, click the button  and enter the MAC address in the appeared field. To remove an address from the list, click the button  in the corresponding line.

If there is a need to add to the list the MAC address of the client that is currently connected to the base station, click the button  at the end of the line and select the desired address from the list, it will automatically be added to the field.

By default, the list displays up to 10 addresses. To see the full list if it contains more than 10 addresses, click the “Show all” button.

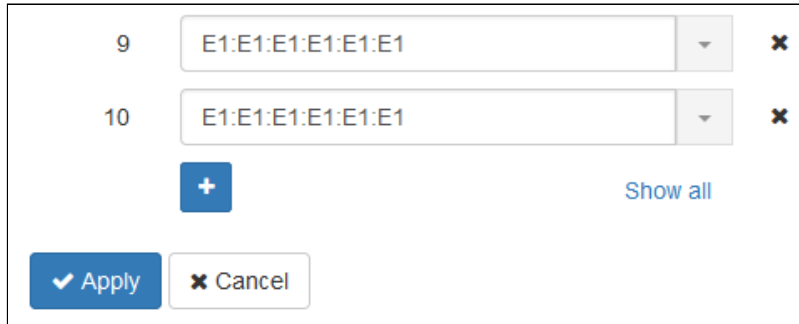

9	E1:E1:E1:E1:E1:E1	▼	✕
10	E1:E1:E1:E1:E1:E1	▼	✕

 [Show all](#)

To apply a new configuration and save settings to non-volatile memory, click “Apply”. Click “Cancel” to discard the changes.

## 5.7 The “WDS” menu

The WDS menu configures wireless bridges between WEP-200L.

- ✔ When configuring a WDS connection, it is necessary to select the same channel and channel width in the radio interface settings on the the devices that will be connected via WDS.

### 5.7.1 The “WDS” submenu

The screenshot shows the WDS configuration page for WEP-200L. The page has a navigation bar with tabs: Monitoring, Radio, VAP, WDS (selected), Network Settings, External Services, and System. The language is set to 'en' and there is a '(logout)' link. The WDS configuration is shown for the 5 GHz band. The 'Enabled' checkbox is checked. The 'Security Mode' is set to 'Off'. The 'Local MAC' is 68:13:E2:0F:94:E0. Below, there is a table for 'WDS Interfaces' with columns for Interface, Remote MAC, and Fixed Transmit Rate. The table lists wlan0-wds0 through wlan0-wds3, each with a checkbox, a Remote MAC input field, and a Fixed Transmit Rate dropdown menu set to 'Auto'. At the bottom, there are 'Apply' and 'Cancel' buttons.

In the "2.4 GHz" and "5 GHz" tabs, select the radio interface of the device on which a wireless bridge should be built.

- *Enabled* – if the flag is selected, the wireless bridge mode is enabled, otherwise it is disabled;
- *Security mode* – wireless access security mode:
  - *Off* – do not use encryption for data transfer;
  - *WPA2* – encryption method, when selected, the following setting will be available:
    - *WPA key* – key/password required to connect to the remote access point. The key length is from 8 to 63 characters.
- *Local MAC* – MAC address of this device radio interface;
- *Interface* – selecting and enabling the WDS interface on which the wireless bridge will be built;
- *Remote MAC* – MAC address of the remote device radio interface, to which a wireless bridge is configured;
- *Fixed Transmit Rate* – fixed wireless data rate, defined by the specifications of the IEEE 802.11 standards. For each interface, select individually.

To apply a new configuration and save settings to non-volatile memory, click “Apply”. Click “Cancel” to discard the changes.

## 5.8 The “Network Settings” menu

### 5.8.1 The “System Configuration” submenu

The screenshot shows the ELTEX WEP-200L web interface. The top navigation bar includes 'Monitoring', 'Radio', 'VAP', 'WDS', 'Network Settings' (selected), 'External Services', 'System', 'en', and '(logout)'. The 'Network Settings' section is titled 'System Configuration >' and contains a sidebar with 'Access' and a main configuration area. The configuration area includes the following fields:

- Hostname: WEP-200L
- AP Location: root
- Management VLAN: Disabled (dropdown)
- Protocol: DHCP (dropdown)
- Primary DNS Server: XXX:XXX:XXX:XXX
- Secondary DNS Server: XXX:XXX:XXX:XXX

At the bottom of the configuration area are two buttons: 'Apply' and 'Cancel'.

- *Hostname* – network name of the device, specified by string from 1 to 63 characters; latin uppercase and lowercase letters, digits, hyphen “-” (hyphen can not be the last character in the name);
- *AP Location* – domain of the EMS management system tree host where the access point is located;
- *Management VLAN*:
  - *Disabled* – Management VLAN is not used;
  - *Terminating* – the mode in which the management VLAN is terminated at the access point (in this case, clients connected via the radio interface do not have access to this VLAN. With WDS configured on the access point, this management VLAN mode is not available for choice.);
  - *Forwarding* – the mode in which the management VLAN is also transmitted to the radio interface (with the appropriate VAP configuration).
- *VLAN ID* – the VLAN ID used to access the device, takes values 1–4094;
- *Protocol* – select protocol for connection of the device via Ethernet interface to service provider network:
  - *DHCP* – operation mode, when IP address, subnet mask, DNS server address, default gateway and other parameters required for operation are obtained from DHCP server automatically;
  - *Static* – operation mode, when IP address and all the necessary parameters for WAN interface are assigned statically. If “Static” is selected, the following parameters will be available to set:
    - *Static IP* – IP address of the device WAN interface in the provider network;
    - *Netmask* – external subnet mask;
    - *Gateway* – address, to which the packet is sent, if the route in routing table is not found for it.
- *Primary DNS server, Secondary DNS server* – IP addresses of DNS servers. If addresses of DNS servers are not automatically assigned via DHCP, set them manually.

To apply a new configuration and save settings to non-volatile memory, click “Apply”. Click “Cancel” to discard the changes.



## 5.8.2 The “Access” submenu

In the “**Access**” submenu, the access to the device via Web interface, Telnet, SSH, NETCONF and SNMP can be configured.

- To enable access to the device via the web interface via HTTP protocol, set the flag next to “WEB”. In the window that appears, it is possible to change the HTTP port (by default: 80). The range of acceptable values of ports, in addition to the default, from 1025 to 65535 inclusive;
- To enable access to the device via the web interface via HTTPS protocol, set the flag next to “WEB-HTTPS”. In the window that appears, it is possible to change the HTTPS port (by default: 443). The range of acceptable values of ports, in addition to the default, from 1025 to 65535 inclusive;

✔ Note that the ports for the HTTP and HTTPS protocols should not have the same value.

- To enable access to the device via Telnet, check the box next to “Telnet”;
- To enable access to the device via SSH, check the box next to “SSH”;
- To enable access to the device via NETCONF, check the box next to “NETCONF”.

The screenshot displays the 'Access' configuration page in the WEP-200L web interface. The page is titled 'WEP-200L' and features a navigation menu with 'Network Settings' selected. The 'Access' submenu is expanded, showing configuration options for WEB, WEB-HTTPS, Telnet, SSH, NETCONF, and SNMP, all of which are checked. Below these are fields for roCommunity (public), rwCommunity (private), TrapSink, Trap2Sink, InformSink, Sys Name (WEP-200L), Sys Contact (Contact), Sys Location (Russia), and Trap Community (trap). At the bottom are 'Apply' and 'Cancel' buttons.

The WEP-200L software allows changing the device configuration, monitoring the status of the access point and its sensors, as well as managing the device using the SNMP protocol.

To change the SNMP settings, check the box next to “SNMP”, the following SNMP agent options become available:

- *roCommunity* – a password to read the parameters (by default: *public*);
- *rwCommunity* – a password to write parameters (by default: *private*);
- *TrapSink* – IP address or domain name of SNMPv1-trap message recipient in HOST [COMMUNITY [PORT]] format;
- *Trap2Sink* – IP address or domain name of SNMPv2-trap message recipient in HOST [COMMUNITY [PORT]] format;
- *InformSink* – IP address or domain name of Inform message recipient in HOST [COMMUNITY [PORT]] format;
- *Sys Name* – device name;
- *Sys Contact* – device vendor contact information;
- *Sys Location* – device location information;
- *Trap community* – password enclosed in traps (default value: trap).

The list of objects which are supported for reading and configuring via SNMP is given below:

- *eltexLtd.1.127.1* – monitoring of access point parameters and connected client devices;
- *eltexLtd.1.127.3* – access point management;
- *eltexLtd.1.127.5* – access point configuring.

where *eltexLtd* – 1.3.6.1.4.1.35265 is Eltex Enterprise ID.

See detailed [OID description on WEP/WOP-xL](#).

To apply a new configuration and save settings to non-volatile memory, click “Apply”. Click “Cancel” to discard the changes.

## 5.9 The “External Services” menu

### 5.9.1 The “Captive Portal” submenu

The “**Captive Portal**” submenu is designed to enable and configure the APB service at the access point.

The APB service is used to provide portal roaming of clients between access points connected to the service.

- *Enable* – when checked, the access point will connect to the APB service, the address of which is specified in the “Roaming Service URL” field, to provide portal roaming of clients;
- *Roaming Service URL* – APB service address to support roaming in the portal authorization mode. Set in format: “ws://<host>:<port>/apb/broadcast”.

To apply a new configuration and save settings to non-volatile memory, click “Apply”. Click “Cancel” to discard the changes.

### 5.9.2 The “AirTune” submenu

The “**AirTune**” submenu is designed to enable and configure the AirTune service at the access point.

The AirTune service is used to optimize Radio Resource Management and to automatically configure seamless roaming (802.11 k/r).

The screenshot shows the ELTEX WEP-200L web interface. The top navigation bar includes 'Monitoring', 'Radio', 'VAP', 'WDS', 'Network Settings', 'External Services' (selected), and 'System'. On the right, there is a language dropdown set to 'en' and a '(logout)' link. A left sidebar contains 'Captive Portal' and 'AirTune >'. The main configuration area for 'AirTune' includes an 'Enable' checkbox which is checked, and an 'AirTune URL' text input field containing 'ws://192.168.1.1:8099/apb/rrm'. At the bottom of the configuration area are two buttons: 'Apply' (with a checkmark icon) and 'Cancel' (with an 'x' icon).

- *Enable* – when checked, the access point will connect to the AirTune service, the address of which is specified in the “AirTune URL” field, to provide functions of Radio Resource Management or/and roaming 802.11 k/r;
- *AirTune URL* – AirTune service address. Set in format: "ws://<host>:<port>/apb/rrm".

To apply a new configuration and save settings to non-volatile memory, click “Apply”. Click “Cancel” to discard the changes.

## 5.10 The “System” menu

In the “**System**” menu, the user can configure the system, time, device access via different protocols, change password, and update device firmware.

### 5.10.1 The “Device Firmware Upgrade” submenu

The “**Device Firmware Upgrade**” submenu is intended for upgrading the device firmware.

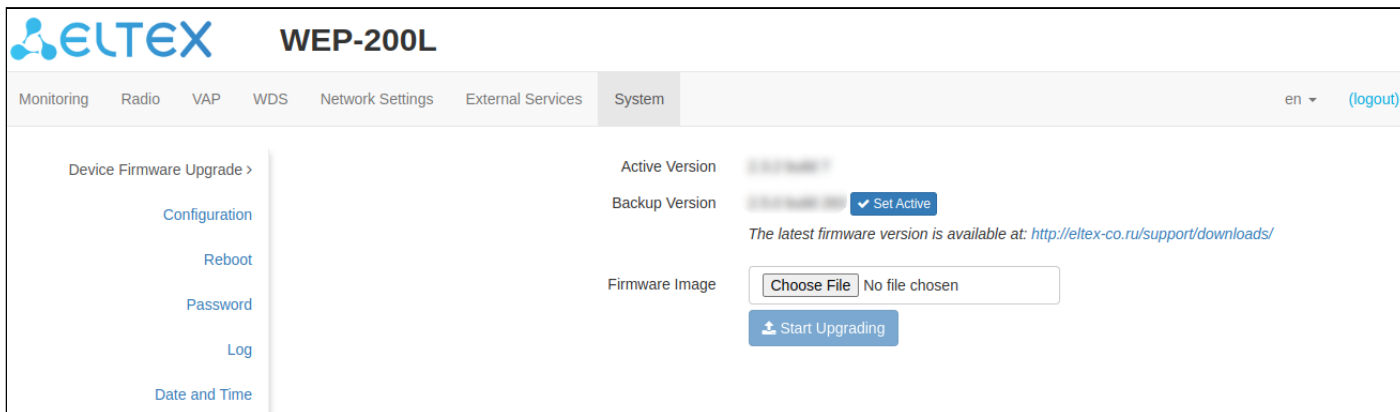

- *Active Version* — installed firmware version, which is operating at the moment;
- *Backup Version* — installed firmware version which can be used in case of problems with the current active firmware version;
  - *Set Active* — a button that allows one to make a backup version of the firmware active, this will require a device reboot. The active firmware version will not be set as a backup.

### Firmware upgrade

Download the firmware file from <http://eltex-co.com/support/downloads/>, select “Wireless” → “Enterprise Wi-Fi Access Points” → “WEP-200L” and save it on your computer. After that, click “Choose File” in the Firmware Image field and specify the path to the firmware file in .tar.gz format.

To start the upgrade process, click the “Start Upgrading”. The process may take several minutes (its current status will be shown on the page). The device will be automatically rebooted when the upgrade is completed.

⚠ Do not switch off or reboot the device during a firmware upgrade.

### 5.10.2 The “Configuration” submenu

In the “**Configuration**” submenu, the current configuration can be saved and updated.

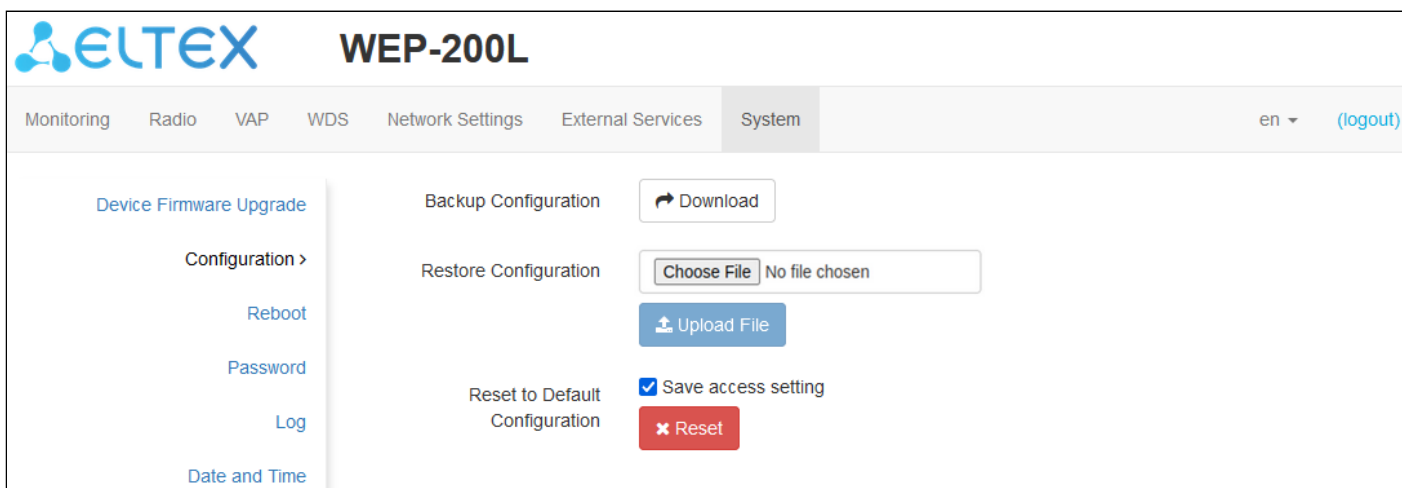

#### Backup Configuration

To save current device configuration to local computer click “Download”.

#### Restore Configuration

To upload the configuration file saved on the local computer, use the *Restore Configuration* item. To update the device configuration click “Choose File”, specify a file (in .tar.gz format) and click “Upload File”. Uploaded configuration will be applied automatically and does not require device reboot.

#### Reset to Default Configuration

To reset all the settings to default values, click “Reset”. If the flag “Save access setting” is activated, then those settings, configurations that are responsible for access to the device (IP address settings, Telnet/SSH/SNMP/Netconf/Web access settings) will be saved.

### 5.10.3 The “Reboot” submenu

To reboot the device, click “Reboot”. The device reboot process takes about 1 minute.

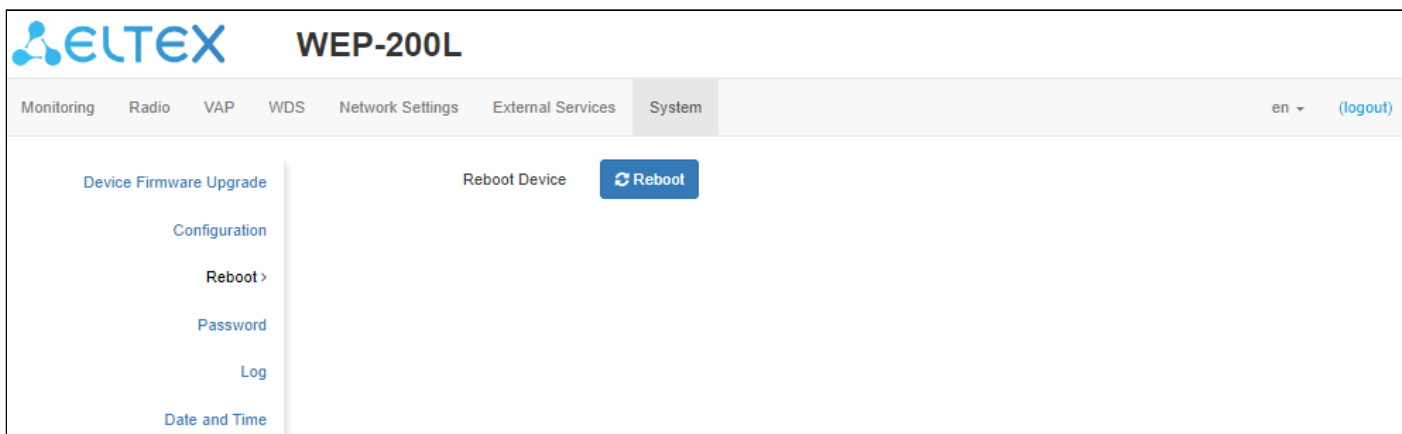

#### 5.10.4 The “Password” submenu

When logging in via web interface, administrator (default password: **password**) has the full access to the device: read/write any settings, full device status monitoring.

To change the password, enter the new password first in the “Password” field, then in the “Confirm Password” field, and click “Apply” to save the new password.

#### 5.10.5 The “Log” submenu

The “**Log**” submenu is designed to configure the output of various kinds of debugging messages of the system in order to detect the causes of problems in the operation of the device.

- *Mode* – Syslog agent operation mode:
  - *Local File* – log information is stored in a local file and is available in the device web interface on the “Monitoring/Events” tab;
  - *Server and File* – log information is sent to a remote Syslog server and stored in a local file.
- *Syslog Server Address* – IP address or domain name of the Syslog server;
- *Syslog Server Port* – port for incoming Syslog server messages (default: 514, valid values: from 1 to 65535);
- *File Size* – maximum size of the log file (valid values: 1–1000 kB).

To apply a new configuration and save settings to non-volatile memory, click “Apply”. Click “Cancel” to discard the changes.

## 5.10.6 The “Date and Time” submenu

In the “**Date and Time**” submenu, it is possible to set the time manually or using the time synchronization protocol (NTP).

### 5.10.6.1 Manual

The screenshot shows the 'Date and Time' configuration page in the WEP-200L web interface. The page is titled 'WEP-200L' and has a navigation menu with 'System' selected. The 'Date and Time' submenu is active, showing options for 'Mode' (Manual selected, NTP Server unselected), 'Date and Time device' (08.08.2023 10:49:26 with an 'Edit' button), 'Time Zone' (Moscow, Russia), 'Enable daylight saving time' (checked), 'DST Start' and 'DST End' (both set to '(not selected)' with time pickers), and 'DST Offset (minutes)' (60). There are 'Apply' and 'Cancel' buttons at the bottom.

- *Date and Time device* – date and time on the device at the current moment. Click “Edit” to make corrections:
  - *Date, Time* – set the current date and time or click “Set current date and time” to synchronize with the device;
- *Time Zone* – allows to set the timezone according to the nearest city for your region from the list;
- *Enable Daylight Saving Time* – when selected, automatic daylight saving change will be performed automatically within the defined time period:
  - *DST Start* – day and time, when daylight saving time is starting;
  - *DST End* – day and time, when daylight saving time is ending;
  - *DST Offset (minutes)* – time period in minutes, on which time offset is performing. The parameter can take a value from 0 to 720 minutes.

## 5.10.6.2 NTP server

The screenshot shows the 'System' configuration page for the WEP-200L device. The left sidebar contains navigation options: Device Firmware Upgrade, Configuration, Reboot, Password, Log, and Date and Time >. The main content area is titled 'System' and includes the following settings:

- Mode:** Radio buttons for 'Manual' and 'NTP Server' (selected).
- Date and Time device:** Text field showing '08.08.2023 10:51:16'.
- NTP Server:** Dropdown menu with 'pool.ntp.org' selected.
- Time Zone:** Dropdown menu with 'Moscow, Russia' selected.
- Enable daylight saving time:** Checked checkbox.
- DST Start:** Three dropdown menus (all showing '(not selected)') followed by 'in', 'at', and two time selection boxes (both showing '--').
- DST End:** Three dropdown menus (all showing '(not selected)') followed by 'in', 'at', and two time selection boxes (both showing '--').
- DST Offset (minutes):** Text field with '60' entered.

At the bottom of the configuration area, there are two buttons: 'Apply' (with a checkmark icon) and 'Cancel' (with an 'x' icon).

- *Date and Time device* – date and time set on the device;
- *NTP Server* – IP address/domain name of the time synchronization server. It is possible to specify an address or select from an existing list;
- *Time Zone* – allows to set the time zone according to the nearest city for your region from the list;
- *Daylight Saving Time Enable* – when selected, automatic daylight saving change will be performed automatically within the defined time period:
  - *DST Start* – day and time, when daylight saving time is starting;
  - *DST End* – day and time, when daylight saving time is ending;
  - *DST Offset (minutes)* – time period in minutes, on which time offset is performing. The parameter can take a value from 0 to 720 minutes.

To apply a new configuration and save settings to non-volatile memory, click “Apply”. Click “Cancel” to discard the changes.



## 6 Managing the device using the command line

- ✔ To display the existing settings of a particular configuration section, enter the **show-config** command. Press the key combination (English layout) – **[Shift + ? ]** to get a hint of what value this or that configuration parameter can take.  
To get a list of options available for editing in this configuration section, press the **Tab** key.  
To save the settings, enter the **save** command.  
To go back to the previous configuration section, enter the **exit** command.  
To go to the root partition, enter the **end** command.

### 6.1 Connection to the device

By default, WEP-200L is configured to receive the address via DHCP. If this does not happen, it is possible to connect to the device using the factory IP address.

- ✔ WEP-200L factory default IP address: **192.168.1.10**, subnet mask: **255.255.255.0**.

Connection to the device is performed via SSH/Telnet:

```
ssh admin@<IP address of the device>, then enter the password
```

```
telnet <IP address of the device>, enter login and password
```

## 6.2 Network parameters configuration

### Configuring the static network parameters of the access point

```

WEP-200L(root):/# configure
WEP-200L(config):/# interface
WEP-200L(config):/interface# br0
WEP-200L(config):/interface/br0# common
WEP-200L(config):/interface/br0/common# static-ip X.X.X.X (where X.X.X.X is WEP-200L IP address)
WEP-200L(config):/interface/br0/common# netmask X.X.X.X (where X.X.X.X is subnet mask)
WEP-200L(config):/interface/br0/common# dns-server-1 X.X.X.X (where X.X.X.X is IP address of the dns
server №1)
WEP-200L(config):/interface/br0/common# dns-server-2 X.X.X.X (where X.X.X.X is IP address of the dns
server №2)
WEP-200L(config):/interface/br0/common# protocol static-ip (change operation mode from DHCP to
Static-IP)
WEP-200L(config):/interface/br0/common# save (save changes)

```

### Adding a static route

```

WEP-200L(config):/interface/br0/common# exit
WEP-200L(config):/interface/br0# exit
WEP-200L(config):/interface# exit
WEP-200L(config):/# route
WEP-200L(config):/route# add default (where default is route name)
WEP-200L(config):/route# default
WEP-200L(config):/route/default# destination X.X.X.X (where X.X.X.X is IP address of the network or
destination node, for default route is 0.0.0.0)
WEP-200L(config):/route/default# netmask X.X.X.X (where X.X.X.X is destination network mask, for
default route is 0.0.0.0)
WEP-200L(config):/route/default# gateway X.X.X.X (where X.X.X.X is gateway IP address)
WEP-200L(config):/route/default# save (save changes)

```

### Configuring the reception of network parameters via DHCP

```

WEP-200L(root):/# configure
WEP-200L(config):/# interface
WEP-200L(config):/interface# br0
WEP-200L(config):/interface/br0# common
WEP-200L(config):/interface/br0/common# protocol dhcp
WEP-200L(config):/interface/br0/common# save (save changes)

```

**Configuring IPv4 access settings**

```

WEP-200L(root):/# configure
WEP-200L(config):/# interface
WEP-200L(config):/interface# br0
WEP-200L(config):/interface/br0# common
WEP-200L(config):/interface/br0/common# access-rules (go to the section of access settings via IPv4 protocol)
WEP-200L(config):/interface/br0/common/access-rules# telnet false (where false is restriction of access via the TELNET protocol to the device by its IPv4 address. This setting applies only to the connection to the device via IPv4, access via IPv6 will remain if the corresponding prohibition setting has not been made in the section for IPv6. To remove the restriction, enter true)
WEP-200L(config):/interface/br0/common/access-rules# save (save changes)

```

- ✓ Starting from software version 2.2.0, it is possible to set the MTU via DHCP (option 26). The MTU value obtained via DHCP takes precedence over the configured setting.

- ⚠ The MTU size for bridge should not be larger than the smallest MTU size on the interfaces that are located in this bridge.

**Configuring the MTU size on interface**

```

WEP-200L(root):/# configure
WEP-200L(config):/# interface
WEP-200L(config):/interface# br0
WEP-200L(config):/interface/br0# common
WEP-200L(config):/interface/br0/common# mtu X (where X is the MTU size in bytes. Possible values: 1–2490)
WEP-200L(config):/interface/br0/common# save (save changes)

```

## 6.2.1 Network parameters configuration via set-management-vlan-mode utility

**Untagged access**

Obtaining the network parameters via DHCP:

```
WEP-200L(root):/# set-management-vlan-mode off protocol dhcp
```

Static settings:

```
WEP-200L(root):/# set-management-vlan-mode off protocol static-ip ip-addr X.X.X.X netmask Y.Y.Y.Y gateway Z.Z.Z.Z (where X.X.X.X is static IP address, Y.Y.Y.Y is subnet mask, Z.Z.Z.Z is gateway)
```

**Access via Management VLAN in Terminating mode**

Obtaining the network parameters via DHCP:

WEP-200L(root):/# **set-management-vlan-mode terminating vlan-id X protocol dhcp** (where X is VLAN ID used for access to the device. Acceptable values: 1–4094)

Static settings:

WEP-200L(root):/# **set-management-vlan-mode terminating vlan-id X protocol static-ip ip-addr**

**X.X.X.X netmask Y.Y.Y.Y gateway Z.Z.Z.Z** (where X is VLAN ID used for access to the device. Acceptable values: 1–4094; X.X.X.X is static IP address, Y.Y.Y.Y is subnet mask, Z.Z.Z.Z is gateway)

**Access via Management VLAN in Forwarding mode**

Obtaining the network parameters via DHCP:

WEP-200L(root):/# **set-management-vlan-mode forwarding vlan-id X protocol dhcp** (where X is VLAN ID used for access to the device. Acceptable values: 1–4094)

Static settings:

WEP-200L(root):/# **set-management-vlan-mode forwarding vlan-id X protocol static-ip ip-addr**

**X.X.X.X netmask Y.Y.Y.Y gateway Z.Z.Z.Z** (where X is VLAN ID used for access to the device. Acceptable values: 1–4094; X.X.X.X is static IP address, Y.Y.Y.Y is subnet mask, Z.Z.Z.Z is gateway)

**Completing and saving settings**

WEP-200L(root):/# **save** (save changes)

## 6.2.2 IPv6 network parameters configuration

❗ Access to the device via IPv6 protocol is disabled by default.

**Enabling access to the device via IPv6 protocol**

WEP-200L(root):/# **configure**

WEP-200L(config):/# **interface**

WEP-200L(config):/interface# **br0**

WEP-200L(config):/interface/br0# **common**

WEP-200L(config):/interface/br0/common# **ipv6**

WEP-200L(config):/interface/br0/common/ipv6# **protocol dhcp** (obtaining IPv6 network parameters via DHCP)

WEP-200L(config):/interface/br0/common/ipv6# **enabled true** (enabling access to the device via IPv6 protocol. To disable, enter **false**)

WEP-200L(config):/interface/br0/common/ipv6# **save** (save changes)

**Configuring static IPv6 network settings for the access point**

```

WEP-200L(root):/# configure
WEP-200L(config):/# interface
WEP-200L(config):/interface# br0
WEP-200L(config):/interface/br0# common
WEP-200L(config):/interface/br0/common# ipv6
WEP-200L(config):/interface/br0/common/ipv6# address
XXXX:XXXX:XXXX:XXXX:XXXX:XXXX:XXXX:XXXX (where
XXXX:XXXX:XXXX:XXXX:XXXX:XXXX:XXXX:XXXX is static IPv6 address of the WEP-200L device)
WEP-200L(config):/interface/br0/common/ipv6# address-prefix-length X (where X is static IPv6 address
prefix. Takes values from 0 to 128. By default: 64)
WEP-200L(config):/interface/br0/common/ipv6# gateway XXXX:XXXX:XXXX:XXXX::/64 (IPv6 prefix is
specified, for example 3211:0:0:1234::/64)
WEP-200L(config):/interface/br0/common/ipv6# dns-server-1
XXXX:XXXX:XXXX:XXXX:XXXX:XXXX:XXXX:XXXX/Y (where
XXXX:XXXX:XXXX:XXXX:XXXX:XXXX:XXXX:XXXX/Y is IPv6 address of the dns server №1 with prefix)
WEP-200L(config):/interface/br0/common/ipv6# dns-server-2
XXXX:XXXX:XXXX:XXXX:XXXX:XXXX:XXXX:XXXX/Y (where
XXXX:XXXX:XXXX:XXXX:XXXX:XXXX:XXXX:XXXX/Y is IPv6 address of the dns server №2 with prefix)
WEP-200L(config):/interface/br0/common/ipv6# protocol static-ip (enable use of static IPv6 networks
parameters. For obtaining the IPv6 network parameters via DHCP enter dhcp)
WEP-200L(config):/interface/br0/common/ipv6# enabled true (enable access to the device via IPv6
protocol. To disable, enter false)
WEP-200L(config):/interface/br0/common/ipv6# save (save changes)

```

**Configuring IPv6 access settings**

```

WEP-200L(root):/# configure
WEP-200L(config):/# interface
WEP-200L(config):/interface# br0
WEP-200L(config):/interface/br0# common
WEP-200L(config):/interface/br0/common# ipv6
WEP-200L(config):/interface/br0/common/ipv6# access-rules (go to the section of access settings)
WEP-200L(config):/interface/br0/common/ipv6/access-rules# telnet false (where false is restriction of
access via the TELNET protocol to the device by its IPv6 address. This setting applies only to connection
to the device via IPv6, access via IPv4 will remain if the corresponding prohibition setting has not been
made in the section for IPv4. To remove the restriction, enter true)
WEP-200L(config):/interface/br0/common/ipv6/access-rules# save (save changes)

```

Similar to restricting access to the device via the TELNET protocol, you can restrict the ability to connection to the device by its IPv6 address using the following protocols: SSH, SNMP, NETCONF, web, web-HTTPS.

### 6.3 Virtual Wi-Fi access points (VAP) configuration

When configuring a VAP, remember that the interface names in the 2.4 GHz band start with wlan0, in the 5 GHz band with wlan1.

Table 8 – Commands for configuring security mode on VAP

Security mode	Command to set the security mode
Without password	mode off
WPA	mode WPA
WPA2	mode WPA2
WPA/WPA2	mode WPA_WPA2
WPA-Enterprise	mode WPA_1X
WPA2-Enterprise	mode WPA2_1X
WPA/WPA2-Enterprise	mode WPA_WPA2_1X

Below are examples of VAP configuration with different security modes for Radio 5 GHz (wlan1).

#### 6.3.1 Configuration of VAP without encryption

##### Creating a VAP without encryption

```
WEP-200L(root):/# configure
WEP-200L(config):/# interface
WEP-200L(config):/interface# wlan1-va0
WEP-200L(config):/interface/wlan1-va0# vap
WEP-200L(config):/interface/wlan1-va0/vap# ssid 'SSID_WEP-200L_open' (change SSID name)
WEP-200L(config):/interface/wlan1-va0/vap# ap-security
WEP-200L(config):/interface/wlan1-va0/vap/ap-security# mode off (encryption mode off is without password)
WEP-200L(config):/interface/wlan1-va0/vap/ap-security# exit
WEP-200L(config):/interface/wlan1-va0# common
WEP-200L(config):/interface/wlan1-va0/common# enabled true (enable VAP)
WEP-200L(config):/interface/wlan1-va0/common# save (save changes)
```

### 6.3.2 Configuration of VAP with WPA-Personal security mode

#### Creating a VAP with WPA-Personal security mode

```
WEP-200L(root):/# configure
WEP-200L(config):/# interface
WEP-200L(config):/interface# wlan1-va0
WEP-200L(config):/interface/wlan1-va0# vap
WEP-200L(config):/interface/wlan1-va0/vap# ssid 'SSID_WEP-200L_Wpa2' (change SSID name)
WEP-200L(config):/interface/wlan1-va0/vap# ap-security
WEP-200L(config):/interface/wlan1-va0/vap/ap-security# mode WPA_WPA2 (encryption mode is WPA/
WPA2)
WEP-200L(config):/interface/wlan1-va0/vap/ap-security# key-wpa password123 (key/password
required to connect to the virtual access point. The key must be between 8 and 63 characters long)
WEP-200L(config):/interface/wlan1-va0/vap/ap-security# exit
WEP-200L(config):/interface/wlan1-va0/vap# exit
WEP-200L(config):/interface/wlan1-va0# common
WEP-200L(config):/interface/wlan1-va0/common# enabled true (enable VAP)
WEP-200L(config):/interface/wlan1-va0/common# save (save changes)
```

### 6.3.3 Configuration of VAP with Enterprise authorization

#### Creating a VAP with WPA2-Enterprise security mode with periodic sending of accounting to a RADIUS server

```

WEP-200L(root):/# configure
WEP-200L(config):/# interface
WEP-200L(config):/interface# wlan1-va0
WEP-200L(config):/interface/wlan1-va0# vap
WEP-200L(config):/interface/wlan1-va0/vap# ssid 'SSID_WEP-200L_enterprise' (change SSID name)
WEP-200L(config):/interface/wlan1-va0/vap# ap-security
WEP-200L(config):/interface/wlan1-va0/vap/ap-security# mode WPA_WPA2_1X (encryption mode is
WPA/WPA2-Enterprise)
WEP-200L(config):/interface/wlan1-va0/vap/ap-security# exit
WEP-200L(config):/interface/wlan1-va0/vap# radius
WEP-200L(config):/interface/wlan1-va0/vap/radius# domain root (where root is user domain)
WEP-200L(config):/interface/wlan1-va0/vap/radius# auth-address X.X.X.X (where X.X.X.X is IP address
of RADIUS server)
WEP-200L(config):/interface/wlan1-va0/vap/radius# auth-port X (where X is port of RADIUS server used
for authentication and authorization. By default: 1812)
WEP-200L(config):/interface/wlan1-va0/vap/radius# auth-password secret (where secret is password
for RADIUS server used for authentication and authorization)
WEP-200L(config):/interface/wlan1-va0/vap/radius# acct-enable true (enable sending of "Accounting"
messages to the RADIUS server. By default: false)
WEP-200L(config):/interface/wlan1-va0/vap/radius# acct-address X.X.X.X (where X.X.X.X is IP address
of RADIUS server used for accounting)
WEP-200L(config):/interface/wlan1-va0/vap/radius# acct-password secret (where secret is password
for RADIUS server used for accounting)
WEP-200L(config):/interface/wlan1-va0/vap/radius# acct-periodic true (enable periodic sending
of "Accounting" messages to the RADIUS server. By default: false)
WEP-200L(config):/interface/wlan1-va0/vap/radius# acct-interval 600 (interval for sending "Accounting"
messages to the RADIUS server)
WEP-200L(config):/interface/wlan1-va0/vap# exit
WEP-200L(config):/interface/wlan1-va0# common
WEP-200L(config):/interface/wlan1-va0/common# enabled true (enable VAP)
WEP-200L(config):/interface/wlan1-va0/common# save (save changes)

```



## 6.3.4 Configuration of VAP with Captive Portal

**Commands to configure portal authorization with sending accounting to the Radius server**

```

WEP-200L(root):/# configure
WEP-200L(config):/# interface
WEP-200L(config):/interface# wlan1-va0
WEP-200L(config):/interface/wlan1-va0# vap
WEP-200L(config):/interface/wlan1-va0/vap# vlan-id X (where X is VLAN ID on VAP)
WEP-200L(config):/interface/wlan1-va0/vap# ap-security
WEP-200L(config):/interface/wlan1-va0/vap# mode off (encryption mode off is no password)
WEP-200L(config):/interface/wlan1-va0/vap/ap-security# exit
WEP-200L(config):/interface/wlan1-va0/vap/ap-security# ssid 'Portal_WEP-200L' (change SSID name)
WEP-200L(config):/interface/wlan1-va0/vap# captive-portal
WEP-200L(config):/interface/wlan1-va0/vap/captive-portal# scenarios
WEP-200L(config):/interface/wlan1-va0/vap/captive-portal/scenarios# scenario-redirect
WEP-200L(config):/interface/wlan1-va0/vap/captive-portal/scenarios/scenario-redirect# redirect-url
http://<IP>:<PORT>/eltex_portal/ (specify URL of virtual portal)
WEP-200L(config):/interface/wlan1-va0/vap/captive-portal/scenarios/scenario-redirect# index 1
WEP-200L(config):/interface/wlan1-va0/vap/captive-portal/scenarios/scenario-redirect# virtual-portal-
name default (specify portal name. By default: default)
WEP-200L(config):/interface/wlan1-va0/vap/captive-portal/scenarios/scenario-redirect# exit
WEP-200L(config):/interface/wlan1-va0/vap/captive-portal/scenarios# exit
WEP-200L(config):/interface/wlan1-va0/vap/captive-portal# enabled true
WEP-200L(config):/interface/wlan1-va0/vap/captive-portal# exit
WEP-200L(config):/interface/wlan1-va0/vap# radius
WEP-200L(config):/interface/wlan1-va0/vap/radius# domain root (where root is user domain)
WEP-200L(config):/interface/wlan1-va0/vap/radius# acct-enable true (enable sending of "Accounting"
messages to the RADIUS server. By default: false)
WEP-200L(config):/interface/wlan1-va0/vap/radius# acct-address X.X.X.X (where X.X.X.X is IP address
of RADIUS server used for accounting)
WEP-200L(config):/interface/wlan1-va0/vap/radius# acct-password secret (where secret is password for
RADIUS server used for accounting)
WEP-200L(config):/interface/wlan1-va0/vap/radius# acct-periodic true (enable periodic sending of
"Accounting" messages to the RADIUS server. By default: false)
WEP-200L(config):/interface/wlan1-va0/vap/radius# acct-interval 600 (interval for sending "Accounting"
messages to the RADIUS server)
WEP-200L(config):/interface/wlan1-va0/vap# exit
WEP-200L(config):/interface/wlan1-va0# common
WEP-200L(config):/interface/wlan1-va0/common# enabled true (enable VAP)
WEP-200L(config):/interface/wlan1-va0/common# save (save changes)

```

### 6.3.5 Advanced VAP settings

#### Assigning VLAN-ID on VAP

WEP-200L(config):/interface/wlan1-va0/vap# **vlan-id X** (where X is VLAN ID number on VAP)

#### Enabling Band Steer mode

WEP-200L(config):/interface/wlan1-va0/vap# **band-steer-mode true** (enabling Band Steer mode. To disable, enter **false**)

#### Enabling VLAN trunk on VAP

WEP-200L(config):/interface/wlan1-va0/vap# **vlan-trunk true** (enabling VLAN trunk on VAP. To disable, enter **false**)

#### Enabling General VLAN on VAP

WEP-200L(config):/interface/wlan1-va0/vap# **general-vlan-mode true** (enabling General VLAN on SSID. To disable, enter **false**)

WEP-200L(config):/interface/wlan1-va0/vap# **general-vlan-id X** (where X is General VLAN number)

#### Selecting the prioritization method

WEP-200L(config):/interface/wlan1-va0/vap# **priority-by-dscp false** (priority analysis from CoS field (Class of Service) of the tagged packets. Value by default: **true**. In this case, the priority from DSCP header field of the IP packet is analyzed)

#### Enabling MFP (802.11W)

WEP-200L(config):/interface/wlan1-va0/vap# **mfp required** (enable management frame protection. **required** – requires MFP support from client, clients without an MFP support will not be able to connect. **capable** – compatible with MFP, clients without an MFP support can connect. To disable, enter **off**)

#### Enabling use of TLS at authorization

WEP-200L(config):/interface/wlan1-va0/vap/radius# **tls-enable true** (use TLS for authorization process. To disable, enter **false**)

**Enabling hidden SSID**

WEP-200L(config):/interface/wlan1-va0/vap# **hidden true** (enabling hidden SSID. To disable, enter **false**)

**Enabling client isolation on VAP**

WEP-200L(config):/interface/wlan1-va0/vap# **station-isolation true** (enable traffic isolation between clients within a single VAP. To disable, enter **false**)

**Client limitation on VAP**

WEP-200L(config):/interface/wlan1-va0/vap# **sta-limit X** (where X is the maximum allowable number of clients connected to the virtual network)

**Enabling multicast replication on VAP**

WEP-200L(config):/interface/wlan1-va0/vap# **wmf-bss-enable true** (enable multicast traffic replication on VAP. To disable, enter **false**)

**Enabling Minimal Signal and Roaming Signal**

WEP-200L(config):/interface/wlan1-va0/vap# **check-signal-enable true** (enabling Minimal Signal. To disable, enter **false**)

WEP-200L(config):/interface/wlan1-va0/vap# **min-signal X** (where X is RSSI threshold, when reached, the access point will disconnect the client from the VAP. The parameter can take values from -100 to -1)

WEP-200L(config):/interface/wlan1-va0/vap# **check-signal-timeout X** (where X is period of time in seconds after which decision is made to disconnect the client equipment from the VAP)

WEP-200L(config):/interface/wlan1-va0/vap# **roaming-signal X** (where X is RSSI threshold, when reached, the client equipment switch to another access point. The parameter can take values from -100 to -1. The roaming-signal parameter should be higher than min-signal: if min-signal = -75 dBm, roaming-signal should be equal, for example, -70 dBm)

WEP-200L(config):/interface/wlan1-va0/vap# **save** (save changes)

**Enabling subscribers traffic transmission outside of GRE tunnel**

WEP-200L(config):/interface/wlan1-va0/vap# **local-switching true** (enabling subscribers traffic transmission outside of GRE tunnel. To disable, enter **false**. By default: disabled)

## Configuring speed limit

### Configuring traffic shaper from the clients (each separately) connected to this VAP towards the access point:

```
WEP-200L(config):/interface/wlan1-va0/vap# shaper-per-sta-rx
WEP-200L(config):/interface/wlan1-va0/vap/shaper-per-sta-rx# value X (where X is maximum speed in Kbps)
WEP-200L(config):/interface/wlan1-va0/vap/shaper-per-sta-rx# mode kbps (enabling shaper. To disable, enter off)
WEP-200L(config):/interface/wlan1-va0/vap/shaper-per-sta-rx# exit
WEP-200L(config):/interface/wlan1-va0/vap# save (save changes)
```

### Configuring traffic shaper from the access point towards the clients (each separately) connected to this VAP:

```
WEP-200L(config):/interface/wlan1-va0/vap# shaper-per-sta-tx
WEP-200L(config):/interface/wlan1-va0/vap/shaper-per-sta-tx# value X (where X is maximum speed in Kbps)
WEP-200L(config):/interface/wlan1-va0/vap/shaper-per-sta-tx# mode kbps (enabling shaper. To disable, enter off)
WEP-200L(config):/interface/wlan1-va0/vap/shaper-per-sta-tx# exit
WEP-200L(config):/interface/wlan1-va0/vap# save (save changes)
```

### Configuring shaper from the clients (in total) connected to this VAP towards the access point:

```
WEP-200L(config):/interface/wlan1-va0/vap# shaper-per-vap-rx
WEP-200L(config):/interface/wlan1-va0/vap/shaper-per-vap-rx# value X (where X is maximum speed in Kbps)
WEP-200L(config):/interface/wlan1-va0/vap/shaper-per-vap-rx# mode kbps (enabling shaper. To disable, enter off)
WEP-200L(config):/interface/wlan1-va0/vap/shaper-per-vap-rx# exit
WEP-200L(config):/interface/wlan1-va0/vap# save (save changes)
```

### Configuring shaper from the access point towards the clients (in total) connected to this VAP:

```
WEP-200L(config):/interface/wlan1-va0/vap# shaper-per-vap-tx
WEP-200L(config):/interface/wlan1-va0/vap/shaper-per-vap-tx# value X (where X is maximum speed in Kbps)
WEP-200L(config):/interface/wlan1-va0/vap/shaper-per-vap-tx# mode kbps (enabling shaper. To disable, enter off)
WEP-200L(config):/interface/wlan1-va0/vap/shaper-per-vap-tx# exit
WEP-200L(config):/interface/wlan1-va0/vap# save (save changes)
```

### Configuring MAC access control

```
WEP-200L(config):/interface/wlan1-va0/vap# acl
WEP-200L(config):/interface/wlan1-va0/vap/acl# mac
WEP-200L(config):/interface/wlan1-va0/vap/acl/mac# add XX:XX:XX:XX:XX:XX (where
XX:XX:XX:XX:XX:XX is MAC address of the device, to which it is required to allow/deny access. To remove
an address from the list, use the del command)
WEP-200L(config):/interface/wlan1-va0/vap/acl/mac# exit
WEP-200L(config):/interface/wlan1-va0/vap/acl# policy allow (policy selection. Possible values: allow –
allow connections only to those clients whose MAC addresses are in the list; deny – deny connections to
clients whose MAC addresses are in the list. By default: deny)
WEP-200L(config):/interface/wlan1-va0/vap/acl# enable true (enabling MAC access control. To disable,
enter false)
```

### Configuring connection blocking for users who spoof the MAC address of a wired network device

If, for security reasons, it is necessary to implement protection against connections of users duplicating the MAC address of a wired device (gateway, PC, etc.), use the **fdb-filtering** setting, which has the following operating modes:

**on-connect** mode blocks all devices connection attempts via Wi-Fi if the MAC address has already been learned on the Ethernet port of the access point;

**by-eth-event** mode disconnects a connected client via Wi-Fi if its MAC address has been learned on the Ethernet port of the access point (the mode helps clear the old client record when roaming);

**full** mode combines all the previous ones, that is, it blocks the connection of a new user via Wi-Fi and disconnects the previously connected one if its MAC address matches with the device connected to the Ethernet interface.

⚠ When setting the **full** and **on-connect** modes, the roaming of Wi-Fi clients may deteriorate. So, during operation, all broadcast packets from a client reach the other access points of the network and its MAC is learned on all network access points, so when the client roaming, if its MAC address is in the Ethernet port list, reconnection may take a long time.

```
WEP-200L(config):/interface/wlan1-va0/vap# fdb-filtering
WEP-200L(config):/interface/wlan1-va0/vap/fdb-filtering # enabled true (enabling function. To disable,
enter false. Default: false)
WEP-200L(config):/interface/wlan1-va0/vap/fdb-filtering #mode full (operating mode selection. Default:
by-eth-event)
```

## 802.11r configuration

This type of roaming is available only for client devices supporting 802.11r.

802.11r roaming is possible only between VAPs with WPA2-Personal and WPA2-Enterprise security modes. See instructions for configuring VAP with WPA2-Personal security mode and others in [Configuration of VAP with WPA-Personal security mode](#) section.

Each VAP on the access points should be configured individually, eg. AP1(wlan1) ↔ AP2(wlan1), AP1(wlan0) ↔ AP2(wlan0), AP1(wlan1) ↔ AP3(wlan1), etc.

Below is the example of 802.11r configuring on two access points: AP1 and AP2.

### Configuring 802.11r on AP1

```

WEP-200L(config):/interface/wlan1-va0/vap/ft-config# enabled false
WEP-200L(config):/interface/wlan1-va0/vap/ft-config# r1-key-holder-id E8:28:C1:FC:D6:80 (MAC address of the VAP. Can be viewed in ifconfig command output)
WEP-200L(config):/interface/wlan1-va0/vap/ft-config# r0-key-holder-id 12345 (unique key for this VAP)
WEP-200L(config):/interface/wlan1-va0/vap/ft-config# mobility-domain 100 (domain should match on remote VAPs)
WEP-200L(config):/interface/wlan1-va0/vap/ft-config# mac
WEP-200L(config):/interface/wlan1-va0/vap/ft-config/mac# add E4:5A:D4:E2:C4:B0 (MAC address of VAP interface of remote access point: AP2)
WEP-200L(config):/interface/wlan1-va0/vap/ft-config/mac# E4:5A:D4:E2:C4:B0
WEP-200L(config):/interface/wlan1-va0/vap/ft-config/mac/E4:5A:D4:E2:C4:B0# r0-kh-id 23456 (unique key of remote VAP access point AP2: r0-key-holder-id)
WEP-200L(config):/interface/wlan1-va0/vap/ft-config/mac/E4:5A:D4:E2:C4:B0# r1-kh-id E4:5A:D4:E2:C4:B0 (MAC address of remote VAP on AP2)
WEP-200L(config):/interface/wlan1-va0/vap/ft-config/mac/E4:5A:D4:E2:C4:B0# r0-kh-key 0102030405060708 (random key. It shouldn't match with r1-kh-key of AP1, but it should match with r1-kh-key of remote AP2)
WEP-200L(config):/interface/wlan1-va0/vap/ft-config/mac/E4:5A:D4:E2:C4:B0# r1-kh-key 0001020304050607 (random key. It shouldn't match with r0-kh-key of AP1, but it should match with r0-kh-key of remote AP2)
WEP-200L(config):/interface/wlan1-va0/vap/ft-config/mac/E4:5A:D4:E2:C4:B0# exit
WEP-200L(config):/interface/wlan1-va0/vap/ft-config/mac# exit
WEP-200L(config):/interface/wlan1-va0/vap/ft-config# enabled true (enable access point operation by 802.11r protocol)
WEP-200L(config):/interface/wlan1-va0/vap/ft-config# save (save changes)

```

**Configuring 802.11r on AP2**

```
WEP-200L(config):/interface/wlan1-va0/vap/ft-config# enabled false
WEP-200L(config):/interface/wlan1-va0/vap/ft-config# r1-key-holder-id E4:5A:D4:E2:C4:B0 (MAC address of the VAP. Can be viewed in ifconfig command output)
WEP-200L(config):/interface/wlan1-va0/vap/ft-config# r0-key-holder-id 23456 (unique key for this VAP)
WEP-200L(config):/interface/wlan1-va0/vap/ft-config# mobility-domain 100 (domain should match on remote VAPs)
WEP-200L(config):/interface/wlan1-va0/vap/ft-config# mac
WEP-200L(config):/interface/wlan1-va0/vap/ft-config/mac# add E8:28:C1:FC:D6:80 (MAC address of VAP interface of remote access point: AP1)
WEP-200L(config):/interface/wlan1-va0/vap/ft-config/mac# E8:28:C1:FC:D6:80
WEP-200L(config):/interface/wlan1-va0/vap/ft-config/mac/E8:28:C1:FC:D6:80# r0-kh-id 12345 (unique key of remote VAP access point AP1: r0-key-holder-id)
WEP-200L(config):/interface/wlan1-va0/vap/ft-config/mac/E8:28:C1:FC:D6:80# r1-kh-id E8:28:C1:FC:D6:80 (MAC address of remote VAP on AP1)
WEP-200L(config):/interface/wlan1-va0/vap/ft-config/mac/E8:28:C1:FC:D6:80# r0-kh-key 0001020304050607 (random key. It shouldn't match with r1-kh-key of AP2, but it should match with r1-kh-key of remote AP1)
WEP-200L(config):/interface/wlan1-va0/vap/ft-config/mac/E8:28:C1:FC:D6:80# r1-kh-key 0102030405060708 (random key. It shouldn't match with r0-kh-key of AP2, but it should match with r0-kh-key of remote AP1)
WEP-200L(config):/interface/wlan1-va0/vap/ft-config/mac/E8:28:C1:FC:D6:80# exit
WEP-200L(config):/interface/wlan1-va0/vap/ft-config/mac# exit
WEP-200L(config):/interface/wlan1-va0/vap/ft-config# enabled true (enable access point operation by 802.11r protocol)
WEP-200L(config):/interface/wlan1-va0/vap/ft-config# save (save changes)
```

## 802.11k configuration

802.11k protocol roaming can be organized between any networks (open/secure). If the access point is configured to work using the 802.11k protocol, then when a client connects, the access point sends the list of “friendly” access points to which a client can switch in a roaming process. The list contains information about access points' MAC addresses and channels they work with.

The use of 802.11k allows to reduce the time for finding another network when roaming, since the client does not need to scan channels on which there are no target access points available for switching.

This type of roaming is available only for client devices supporting 802.11k.

Below is the example of 802.11k configuring access point – making a list of “friendly” access points.

### 802.11k configuring

```
WEP-200L(config):/interface/wlan1-va0/vap/w80211kv-config# enabled false
WEP-200L(config):/interface/wlan1-va0/vap/w80211kv-config# mac
WEP-200L(config):/interface/wlan1-va0/vap/w80211kv-config/mac# add E8:28:C1:FC:D6:90 (where
E8:28:C1:FC:D6:90 is MAC address of “friendly” access point)
WEP-200L(config):/interface/wlan1-va0/vap/w80211kv-config/mac# E8:28:C1:FC:D6:90
WEP-200L(config):/interface/wlan1-va0/vap/w80211kv-config/mac/E8:28:C1:FC:D6:90# channel 132
(where 132 is channel on which access point with E8:28:C1:FC:D6:90 MAC address operates)
WEP-200L(config):/interface/wlan1-va0/vap/w80211kv-config/mac/E8:28:C1:FC:D6:90# exit
WEP-200L(config):/interface/wlan1-va0/vap/w80211kv-config/mac# add E8:28:C1:FC:D6:70 (where
E8:28:C1:FC:D6:70 is MAC address of “friendly” access point)
WEP-200L(config):/interface/wlan1-va0/vap/w80211kv-config/mac# E8:28:C1:FC:D6:70
WEP-200L(config):/interface/wlan1-va0/vap/w80211kv-config/mac/E8:28:C1:FC:D6:70# channel 36
(where 36 is channel on which access point with E8:28:C1:FC:D6:70 MAC address operates)
WEP-200L(config):/interface/wlan1-va0/vap/w80211kv-config/mac/E8:28:C1:FC:D6:70# exit
WEP-200L(config):/interface/wlan1-va0/vap/w80211kv-config/mac# exit
WEP-200L(config):/interface/wlan1-va0/vap/w80211kv-config# enabled true (enabling access point
operation via 802.11k protocol)
WEP-200L(config):/interface/wlan1-va0/vap/w80211kv-config# save (save changes)
```



## 6.4 Radio configuration

In the Radio section, automatic selection of the working channel is used by default. To set the channel manually or change the power, use the following commands:

### Change of operation channel and radio interface power

```
WEP-200L(root):/# configure
WEP-200L(config):/# interface
WEP-200L(config):/interface# wlan0
WEP-200L(config):/interface/wlan0# wlan
WEP-200L(config):/interface/wlan0/wlan# radio
WEP-200L(config):/interface/wlan0/wlan/radio# channel X (where X is the number of the static channel
on which the access point will operate)
WEP-200L(config):/interface/wlan0/wlan/radio# auto-channel false (disabling Auto Channel. To enable,
enter true)
WEP-200L(config):/interface/wlan0/wlan/radio# use-limit-channels false (disabling Use Limit Channels.
To enable, enter true)
WEP-200L(config):/interface/wlan0/wlan/radio# bandwidth X (where X is channel bandwidth. Possible
values: for Radio 1: 20, 40; for Radio 2: 20, 40, 80)
WEP-200L(config):/interface/wlan0/wlan/radio# tx-power X (where X is power level, dBm. Possible
values: for Radio 1: 4-16 dBm; for Radio 2: 8-19 dBm)
WEP-200L(config):/interface/wlan0/wlan/radio# save (save changes)
```

### ✔ Lists of available channels

#### Channels available for selection for radio 2.4 GHz :

- for 20 MHz channel width: 1, 2, 3, 4, 5, 6, 7, 8, 9, 10, 11, 12, 13.
- for 40 MHz channel width:
  - if "control-sideband" = lower: 1, 2, 3, 4, 5, 6, 7, 8, 9.
  - if "control-sideband" = upper: 5, 6, 7, 8, 9, 10, 11, 12, 13.

#### Channels available for selection for radio 5 GHz:

- for 20 MHz channel width: 36, 40, 44, 48, 52, 56, 60, 64, 132, 136, 140, 144, 149, 153, 157, 161, 165.
- for 40 MHz channel width:
  - if "control-sideband" = lower: 36, 44, 52, 60, 132, 140, 149, 157.
  - if "control-sideband" = upper: 40, 48, 56, 64, 136, 144, 153, 161.
- for 80 MHz channel width: 36, 40, 44, 48, 52, 56, 60, 64, 132, 136, 140, 144, 149, 153, 157, 161.

### 6.4.1 Advanced Radio settings

#### Configuring the limited list of channels

WEP-200L(config):/interface/wlan0/wlan/radio# **use-limit-channels true** (enabling use of limited list of channels in channel autoselection operation. To disable, enter **false**)

WEP-200L(config):/interface/wlan0/wlan/radio# **limit-channels '1 6 11'** (where 1, 6, 11 are channels of range in which the configurable radio interface can operate)

#### Changing the primary channel

WEP-200L(config):/interface/wlan0/wlan/radio# **control-sideband lower** (parameter may take values: lower, upper. By default: for Radio 1: lower; for Radio 2: upper)

#### Enabling the use of Short Guard Interval

WEP-200L(config):/interface/wlan0/wlan/radio# **sgi true** (enabling the use of a Short Guard Interval for data transmission of 400 ns instead of 800 ns. To disable, enter **false**)

#### Enabling STBC

WEP-200L(config):/interface/wlan0/wlan/radio# **stbc true** (enabling the Space-Time Block Coding (STBC) method, aimed at improving the reliability of data transmission. To disable, enter **false**)

#### Enabling aggregation

WEP-200L(config):/interface/wlan0/wlan/radio# **aggregation true** (enabling aggregation on Radio: support for AMPDU/AMSDU. To disable, enter **false**)

#### Enabling the short preamble

WEP-200L(config):/interface/wlan0/wlan/radio# **short-preamble true** (enabling the short packet preamble. To disable, enter **false**)

#### Enabling the Wi-Fi Multimedia (WMM)

WEP-200L(config):/interface/wlan0/wlan/radio# **wmm true** (enabling the support for WMM (Wi-Fi Multimedia). To disable, enter **false**)

**Configuring DFS mechanism**

Configuring is done only on Radio 5 GHz (wlan1)

WEP-200L(config):/interface/wlan1/wlan/radio# **dfs X** (where X is DFS mechanism operating mode. Possible values: **forced**: the mechanism is disabled, DFS channels are available for selection; **auto**: the mechanism is enabled; **disabled**: the mechanism is disabled, DFS channels are unavailable for selection)

**Enabling automatic channel width switch mode**

WEP-200L(config):/interface/wlan0/wlan/radio# **obss-coex true** (enabling automatic channel width switch mode from 40 MHz to 20 MHz with a loaded radio environment. To disable, enter **false**)

**Enabling Broadcast/Multicast shaper**

WEP-200L(config):/interface/wlan0/wlan/radio# **tx-broadcast-limit X** (where X is restricting broadcast/multicast traffic over a wireless network, the limit for broadcast traffic is specified, packets/s)

**Enabling QoS and parameter changes**

WEP-200L(config):/interface/wlan0/wlan/radio# **qos**

WEP-200L(config):/interface/wlan0/wlan/radio/qos# **enable true** (enabling the use of Quality of Service functions. To disable, enter **false**)

WEP-200L(config):/interface/wlan0/wlan/radio/qos# **edca-ap** (configuring QoS parameters of the access point, traffic is transmitted from the access point to the client)

WEP-200L(config):/interface/wlan0/wlan/radio/qos/edca-ap# **bk** (configuring QoS parameters for low-priority high-bandwidth queues (802.1p priorities: cs1, cs2))

WEP-200L(config):/interface/wlan0/wlan/radio/qos/edca-ap/bk# **aifs X** (where X is waiting time for frames of data, measured in slots. Takes the values 1–255)

WEP-200L(config):/interface/wlan0/wlan/radio/qos/edca-ap/bk# **cwmin X** (X is the initial value of the time to wait before resending a frame, specified in milliseconds. Accepts values: 1, 3, 7, 15, 31, 63, 127, 255, 511, 1023. The cwMin value cannot exceed the cwMax value)

WEP-200L(config):/interface/wlan0/wlan/radio/qos/edca-ap/bk# **cwmax X** (where X is maximum timeout value before resending a frame, specified in milliseconds. Accepts values: 1, 3, 7, 15, 31, 63, 127, 255, 511, 1023. The cwMax value must be greater than the cwMin value)

WEP-200L(config):/interface/wlan0/wlan/radio/qos/edca-ap/bk# **txop X** (where X is the time interval in milliseconds when the WME client station has the right to initiate data transmission over the wireless medium to the access point. Max value 65535 milliseconds)

WEP-200L(config):/interface/wlan0/wlan/radio/qos/edca-ap/bk# **exit**

WEP-200L(config):/interface/wlan0/wlan/radio/qos/edca-ap# **exit**

WEP-200L(config):/interface/wlan0/wlan/radio/qos# **edca-sta** (configuring QoS parameters of the client station: traffic is transmitted from the client station to the access point)

The configuration method of **edca-sta** is the same as that of **edca-ap**.

Parameters configuration for queues **be**, **vi**, **vo** is similar to parameters configuration for queue **bk**.

## 6.5 DHCP option 82 Configuration

- ✓ DHCP option 82 is configured separately for each radio interface. This section provides examples of configuring option 82 for Radio 2.4 GHz – wlan0.

DHCP snooping operating modes:

- **ignore** – option 82 processing is disabled. Default value;
- **replace** – the access point substitutes or replaces the value of option 82;
- **remove** – the access point removes the value of option 82.

### Changing the operation mode of DHCP option 82

```
WEP-200L(root):/# configure
WEP-200L(config):/# interface
WEP-200L(config):/interface# wlan0 (configuring will be done for Radio 2.4 GHz. To configure option 82 on Radio 5 GHz, enter wlan1)
WEP-200L(config):/interface/wlan0# common
WEP-200L(config):/interface/wlan0/common# dhcp-snooping
WEP-200L(config):/interface/wlan0/common/dhcp-snooping# dhcp-snooping-mode replace (selection of DHCP snooping operation in the mode of replacement or substitution of option 82)
```

If on the radio interface the option 82 processing policy is configured to **replace**, the following parameters become available for configuration:

### Configuring Option 82 parameters

```
WEP-200L(config):/interface/wlan0/common/dhcp-snooping# dhcp-option-82-CID-format custom (where custom is replacement of the CID content with the value specified in the dhcp-option-82-custom-CID parameter. The parameter can take values: APMAC-SSID is replacement of the CID content with <MAC address of the access point>-<SSID name>. SSID is replacement of the CID content with SSID name, to which the client is connected. By default: APMAC-SSID)
WEP-200L(config):/interface/wlan0/common/dhcp-snooping# dhcp-option-82-RID-format custom (where custom is replacement of the RID content with the value specified in the dhcp-option-82-custom-RID parameter. The parameter can take values: ClientMAC is replacement of the RID content with MAC address of the client device. APMAC is replacement of the RID content with MAC address of the access point. APdomain is replacement of the RID content with the domain where the access point is located. By default: ClientMAC)
WEP-200L(config):/interface/wlan0/common/dhcp-snooping# dhcp-option-82-custom-CID longstring (where longstring is value from 1 to 52 characters, which will be transmitted in CID. If the value of dhcp-option-82-custom-CID parameter is not defined, the access point will change the CID to the default value: <MAC address of the access point>-<SSID name>)
WEP-200L(config):/interface/wlan0/common/dhcp-snooping# dhcp-option-82-custom-RID longstring (where longstring is value from 1 to 63 characters, which will be transmitted in RID. If the value of dhcp-option-82-custom-RID parameter is not defined, the access point will change the RID to the default value: MAC address of the client device)
WEP-200L(config):/interface/wlan0/common/dhcp-snooping# dhcp-option-82-MAC-format radius (selecting octet delimiter of the MAC address which is transmitted in RID and CID. radius is a dash is used as a delimiter: AA-BB-CC-DD-EE-FF; default is a colon is used as a delimiter: AA:BB:CC:DD:EE:FF)
```

## 6.6 WDS Configuration

- ✓ When configuring a WDS connection, on the devices that will be connected via WDS, it is necessary to select the same channel and channel width in the radio interface settings. More information about configuring the radio interface via the command line can be found in the [Radio configuration](#) section.

Below is the configuration of a WDS connection on the Radio 5 GHz interface (wlan1).

### WDS configuration

```

WEP-200L(root):/# configure
WEP-200L(config):/# interface
WEP-200L(config):/interface# wlan1-wds0 (WDS link selection. Available values for Radio 2.4 GHz:
wlan0-wds0 - wlan0-wds3; for Radio 5 GHz: wlan1-wds0 - wlan1-wds3)
WEP-200L(config):/interface/wlan1-wds0# wds
WEP-200L(config):/interface/wlan1-wds0/wds# mac-addr XX:XX:XX:XX:XX:XX (MAC address of the
remote access point radio interface, which can be found if you enter on the remote access point the
monitoring radio-interface command)
WEP-200L(config):/interface/wlan1-wds0/wds# exit
WEP-200L(config):/interface/wlan1-wds0# common
WEP-200L(config):/interface/wlan1-wds0/common# enabled true (enabling WDS link. To disable, enter
false)
WEP-200L(config):/interface/wlan1-wds0/common# exit
WEP-200L(config):/interface/wlan1-wds0# exit
WEP-200L(config):/interface# wlan1 (when configuring WDS on Radio 2.4 GHz enter wlan0)
WEP-200L(config):/interface/wlan1# wlan
WEP-200L(config):/interface/wlan1/wlan# wds
WEP-200L(config):/interface/wlan1/wlan/wds# security-mode WPA2 (selection of WPA2 security
mode. Available values: WPA2, off: without password)
WEP-200L(config):/interface/wlan1/wlan/wds# key-wpa password123 (key/password required for
connection to the remote access point. Key length should be between 8 and 63 characters)
WEP-200L(config):/interface/wlan1/wlan/wds# enabled true (enabling WDS. To disable, enter false)
WEP-200L(config):/interface/wlan1/wlan/wds# save

```

The **remote access point** is configured in the same way.

## 6.7 System settings

### 6.7.1 Device firmware update

#### Device firmware update via tftp

WEP-200L(root):/# **firmware upload tftp** <ip address of tftp server> <Firmware file name> (example: `firmware upload tftp 192.168.1.15 WEP-200L-2.3.2_build_X.tar.gz`)

WEP-200L(root):/# **firmware upgrade**

#### Device firmware update via http

WEP-200L(root):/# **firmware upload http** <URL for firmware uploading> (example: `firmware upload http http://192.168.1.100:8080/files/WEP-200L-2.3.2_build_X.tar.gz`)

WEP-200L(root):/# **firmware upgrade**

#### Switching to access point firmware backup

WEP-200L(root):/# **firmware switch**

### 6.7.2 Device configuration management

#### Resetting the device configuration to a default state without saving the access parameters

WEP-200L(root):/# **manage-config reset-to-default**

#### Resetting the device configuration to a default state with saving the access parameters

WEP-200L(root):/# **manage-config reset-to-default-without-management**

#### Download the device configuration file to TFTP server

WEP-200L(root):/# **manage-config download tftp** <tftp server ip address> (example: `manage-config download tftp 192.168.1.15`)

#### Upload configuration file from TFTP server to the device

WEP-200L(root):/# **manage-config upload tftp** <tftp server ip address> <Configuration file name> (example: `manage-config upload tftp 192.168.1.15 config.json`)

WEP-200L(root):/# **manage-config apply** (apply configuration to the access point)

### 6.7.3 Device reboot

#### The command to reboot the device

```
WEP-200L(root):/# reboot
```

### 6.7.4 Authentication Mode Configuration

The device has a factory account *admin* with password *password*. Delete this account recording is not possible. The password can be changed using the following commands.

#### Changing the password for the admin account

```
WEP-200L(root):/# configure
WEP-200L(config):/# authentication
WEP-200L(config):/authentication# admin-password <New password for admin account> (from 1 up to 64 characters, including latin letters and digits)
WEP-200L(config):/authentication# save
```

It is possible to create additional users for local authentication as well as authentication via RADIUS.

- ✔ New users should be assigned one of two roles:
  - admin** is a user with this role will have full access to configuration and monitoring of the base station;
  - viewer** is a user with this role will only have access to monitoring of the base station.

#### Adding new users

```
WEP-200L(root):/# configure
WEP-200L(config):/# authentication
WEP-200L(config):/authentication# user
WEP-200L(config):/authentication/user# add userX (where userX is the name of the new account. To delete, use the del command)
WEP-200L(config):/authentication/user# userX
WEP-200L(config):/authentication/user/userX# login userX (where userX is the name of the new account)
WEP-200L(config):/authentication/user/userX# password <Password for userX account>(from 1 up to 64 characters, including latin letters and digits)
WEP-200L(config):/authentication/user/userX# role admin (the user is given the rights to configure. Possible value viewer is only monitoring will be available to the account)
WEP-200L(config):/authentication/user/userX# save
```

For authentication via RADIUS server, it is necessary to configure access parameters.

**Configuring RADIUS Server Access Settings**

```

WEP-200L(root):/# configure
WEP-200L(config):/# authentication
WEP-200L(config):/authentication# radius
WEP-200L(config):/authentication/radius# auth-address X.X.X.X (where X.X.X.X is IP address of the RADIUS server)
WEP-200L(config):/authentication/radius# auth-port X (where X is RADIUS server port, used for authentication and authorization. By default: 1812)
WEP-200L(config):/authentication/radius# auth-password secret (where secret is key for the RADIUS server, used for authentication and authorization)
WEP-200L(config):/authentication/radius# exit
WEP-200L(config):/authentication# radius-auth true (enabling authentication mode via the RADIUS server. To disable, enter false)
WEP-200L(config):/authentication# save

```

- ✓ When authentication via RADIUS server is used, be sure to create a local account that will be similar to an account on the RADIUS server. In this case, the local account should contain a role that determines access rights (admin or viewer). If the RADIUS server is unavailable, authentication will take place on the local account.

## 6.7.5 Setting the date and time

**Commands to configure NTP server time synchronization**

```

WEP-200L(root):/# configure
WEP-200L(config):/# date-time
WEP-200L(config):/date-time# mode ntp (enabling NTP operation mode)
WEP-200L(config):/date-time# ntp
WEP-200L(config):/date-time/ntp# server <NTP server IP address> (NTP server configuration)
WEP-200L(config):/date-time/ntp# exit
WEP-200L(config):/date-time# common
WEP-200L(config):/date-time/common# timezone 'Asia/Novosibirsk (Novosibirsk)' (timezone configuration)
WEP-200L(config):/date-time/common# save (save changes)

```

## 6.7.6 Advanced system settings

**Enabling global isolation**

```

WEP-200L(root):/# configure
WEP-200L(config):/# system
WEP-200L(config):/system# global-station-isolation true (enabling global traffic isolation between clients of different VAPs and different radio interfaces. To disable, enter false)
WEP-200L(config):/system# save (save changes)

```



**Changing device name**

```
WEP-200L(root):/# configure
WEP-200L(config):/# system
WEP-200L(config):/system# hostname WEP-200L_room2 (where WEP-200L_room2 is a new
device name. The parameter can accept values from 1 to 63 characters: capital and lowercase latin
letters, digits, hyphen character "-" (hyphen can not be the last character in name). By default: WEP-200L)
WEP-200L(config):/system# save (save changes)
```

**Changing geographical domain**

```
WEP-200L(root):/# configure
WEP-200L(config):/# system
WEP-200L(config):/system# ap-location ap.test.root (where ap.test.root is EMS management system
device tree node domain, where access point is located. By default: root)
WEP-200L(config):/system# save (save changes)
```

**Radius NAS-ID changing**

```
WEP-200L(root):/# configure
WEP-200L(config):/# system
WEP-200L(config):/system# nas-id Lenina_1.Novosibirsk.root (where Lenina_1.Novosibirsk.root is the
AP identifier. The parameter is designed for device identification on RADIUS server in case RADIUS
awaits value different from MAC address. Default: AP MAC address)
WEP-200L(config):/system# save (save changes)
```

**Configuring LLDP**

```
WEP-200L(root):/# configure
WEP-200L(config):/# lldp
WEP-200L(config):/lldp# enabled true (enabling LLDP. To disable, enter false. Default: true)
WEP-200L(config):/lldp# tx-interval 60 (changing interval of LLDP message sending. Default: 30)
WEP-200L(config):/lldp# system-name WEP-200L_reserv (where WEP-200L_reserv is new device name.
Default: WEP-200L)
WEP-200L(config):/lldp# save (save changes)
```

## 6.8 APB service configuration

The APB service is used to provide portal roaming of clients between access points connected to the service.

### Commands for APB service configuration

```
WEP-200L(root):/# configure
WEP-200L(config):/# captive-portal
WEP-200L(config):/captive-portal# apbd
WEP-200L(config):/captive-portal/apbd# roam_service_url <APB service address> (example:
roam_service_url ws://192.168.1.100:8090/apb/broadcast)
WEP-200L(config):/captive-portal/apbd# enabled true (enabling APB service. To disable, enter false)
WEP-200L(config):captive-portal/apbd# save (save changes)
```

## 6.9 Monitoring

### 6.9.1 Wi-Fi clients

WEP-200L(root):/# **monitoring associated-clients**

```

index | 0
interface | wlan1-va0
state | ASSOC SLEEP AUTH_SUCCESS
hw-addr | 26:af:0a:30:ef:29
ssid | !!!DOC_test
ip-addr | 169.254.68.250
authorized | true
captive-portal-vap | false
enterprise-vap | false
rx-retry-count | 76
tx-fails | 0
tx-period-retry | 0
tx-retry-count | 0
rssi-1 | -75
rssi-2 | -75
rssi | -75
snr-1 | 17
snr | 17
snr-2 | 16
tx-rate | MCS7 SGI 72.2
rx-rate | MCS7 NO SGI 65
rx-bw | 20M
rx-bw-all | 20M
tx-bw | 20M
mfp | false
uptime | 00:00:27
multicast-groups-count | 0
wireless-mode | n
perftest-capable | false
link-capacity | 0
link-quality | 0
link-quality-common | 0
actual-tx-rate | 0
actual-rx-rate | 0
shaped-rx-rate | 0
actual-tx-pps | 0
actual-rx-pps | 1
shaped-rx-pps | 0
name | 0
    
```

Rate	Transmitted	Received
-----	-----	-----
Total Packets:	2	176
TX success:	100	
Total Bytes:	173	8877
Data Packets:	0	31
Data Bytes:	0	4488
Mgmt Packets:	2	145
Mgmt Bytes:	173	127
Dropped Packets:	0	0

Dropped Bytes: 0 0  
 Lost Packets: 0

Rate	Transmitted		Received	
dsss1	2	100%	37	21%
ofdm6	0	0%	19	10%
ofdm24	0	0%	88	50%
mcs3	0	0%	2	1%
mcs4	0	0%	15	8%
mcs7	0	0%	14	8%

Multicast groups: none

### 6.9.2 WDS

#### WEP-200L(root):/# monitoring wds-entries

```

index | 0
interface | wlan1
state | WIFI_WDS
hw-addr | cc:9d:a2:dd:00:b5
ip-addr | 100.110.0.227
hostname | WEP-200L
authorized | false
captive-portal-vap | false
enterprise-vap | false
rx-retry-count | 10304
tx-fails | 0
tx-period-retry | 38
tx-retry-count | 86
rssi-1 | -29
rssi-2 | -36
rssi-3 | -40
rssi-4 | -36
snr-1 | 38
snr-2 | 37
snr-3 | 36
snr-4 | 36
wds-interface | wlan1-wds0
tx-rate | VHT NSS2-MCS8 SGI 173.3
rx-rate | VHT NSS2-MCS8 NO SGI 156
rx-bw | 20M
rx-bw-all | 20M
tx-bw | 20M
uptime | 00:00:16
multicast-groups-count | 0
wireless-mode | ac
eltex-firmware-version | 1.5.0 build X
eltex-board-type | WEP-200L
perftest-capable | false
snr-rssi-capable | false
link-capacity | 33
link-quality | 97
link-quality-common | 97
actual-tx-rate | 281
actual-rx-rate | 12437
shaped-rx-rate | 0
actual-tx-pps | 116
actual-rx-pps | 16846
shaped-rx-pps | 0
name | 0
    
```

Rate	Transmitted	Received
Total Packets:	1799	299260
TX success:	100	
Total Bytes:	514926	37828573
Data Packets:	1796	299256
Data Bytes:	457310	28251999
Mgmt Packets:	3	4

Mgmt Bytes:		144	408	
Rate	Transmitted		Received	
ofdm6	3	0%	3484	1%
ofdm54	151	8%	0	0%
nss1-mcs1	30	1%	0	0%
nss1-mcs2	0	0%	176	0%
nss1-mcs3	0	0%	132	0%
nss1-mcs4	0	0%	223	0%
nss1-mcs7	0	0%	87	0%
nss2-mcs0	0	0%	64	0%
nss2-mcs1	66	3%	123	0%
nss2-mcs2	177	9%	183	0%
nss2-mcs3	0	0%	310	0%
nss2-mcs4	0	0%	665	0%
nss2-mcs5	447	24%	1318	0%
nss2-mcs6	0	0%	4837	1%
nss2-mcs7	292	16%	31002	10%
nss2-mcs8	633	35%	256655	85%

### 6.9.3 Device information

#### WEP-200L(root):/# monitoring information

```

system-time           | 12:50:37 27.09.2023
uptime                | 00:04:25
software-version      | 2.3.2 build X
secondary-software-version | 2.3.2 build X
boot-version          | 2.1.0 build X
memory-usage          | 43
memory-free           | 137
memory-used           | 104
memory-total          | 241
cpu-load              | 9.5
cpu-average            | 6.70
is-default-config     | false
board-type            | WEP-200L
hw-platform           | WEP-200L
factory-wan-mac       | 68:13:E2:35:C3:90
factory-lan-mac       | 68:13:E2:35:C3:90
factory-serial-number | WP52000345
hw-revision            | 1v2
session-password-initialized | false
ott-mode              | false
last-reboot-reason    | firmware update
test-changes-mode     | false

```

## 6.9.4 Certificate information

### WEP-200L(root):/# **monitoring certificate**

```
ott:
  status: not present
wlc:
  status: present
  url: https://192.168.1.1:8044
```

## 6.9.5 Network information

## WEP-200L(root):/# monitoring wan-status

## Common information:

```

interface           | br0
mac                   | cc:9d:a2:e9:14:70
rx-bytes              | 456875
rx-packets            | 5835
tx-bytes              | 24328
tx-packets            | 241

```

## IPv4 information:

```

protocol              | dhcp
ip-address            | 100.111.66.29
netmask               | 255.255.255.0
gateway               | 100.111.66.1
DNS-1                 | 100.111.66.15
DNS-2                 | 8.8.8.8

```

## IPv6 information:

```

addresses              | 2002::8/128 Global
                       | fe80::ce9d:a2ff:fee9:1470/64 Link
dns-servers            | 2002::4144
                       | 2002::8844
                       | 2222::4144

```

## WEP-200L(root):/# monitoring ethernet

```

link: up
speed: 1000
duplex: enabled
rx-bytes: 4872597
rx-packets: 13844
tx-bytes: 2477091
tx-packets: 20923

```

## WEP-200L(root):/# monitoring arp

#	ip	mac
0	192.168.1.1	02:00:48:xx:xx:xx
1	192.168.1.151	2c:fd:a1:xx:xx:xx

## WEP-200L(root):/# monitoring route

Destination	Gateway	Mask	Flags	Interface
0.0.0.0	192.168.1.1	0.0.0.0	UG	br0
192.168.1.0	0.0.0.0	255.255.255.0	U	br0



## WEP-200L(root):/# monitoring lldp

```

WEP-200L(root):/# monitoring lldp
Port          Device ID          Port ID          System Name      Capabilities TTL
-----
eth0          e0:d9:e3:eb:66:80  gil/0/16 120

```

## 6.9.6 Wireless interfaces

## WEP-200L(root):/# monitoring radio-interface

```

name          | wlan0
status        | on
band          | 2.4 GHz
hwaddr        | E8:28:C1:xx:xx:xx
tx-power      | 16 dBm
noise-1       | -100 dBm
noise-2       | -100 dBm
channel       | 11
frequency     | 2462 MHz
bandwidth     | 20 MHz
utilization   | 0%
thermal       | 35
mode          | b/g/n

name          | wlan1
status        | on
band          | 5 GHz
hwaddr        | E8:28:C1:xx:xx:xx
tx-power      | 19 dBm
noise-1       | -100 dBm
noise-2       | -100 dBm
noise-3       | -100 dBm
noise-4       | -100 dBm
channel       | 36
frequency     | 5180 MHz
bandwidth     | 20 MHz
utilization   | 0%
thermal       | 26
mode          | a/n/ac

```

## 6.9.7 Event logging

### WEP-200L(root):/# monitoring events

```
Jan 23 00:00:07 WEP-200L daemon.info syslogd[925]: started: BusyBox v1.21.1

Jan 23 00:00:09 WEP-200L daemon.info configd[955]: The AP startup configuration was loaded
successfully.

Jan 1 03:00:14 WEP-200L daemon.info networkd[987]: Networkd started

Jan 1 03:01:17 WEP-200L daemon.info networkd[987]: DHCP-client: Interface br0 obtained
lease on 192.168.1.15.

Jan 23 07:17:14 WEP-200L daemon.info monitord[1055]: event: 'associated' mac:
E4:0E:EE:BD:AE:6B ssid: 'WEP-200L_2.4GHz' int0
```

## 6.9.8 Environment scan

 While scanning the environment, the device radio interface will be disabled, which will make it impossible to transfer data to Wi-Fi clients during scanning.

### WEP-200L(root):/# monitoring scan-wifi

SSID	Mode	Security	BSSID	Channel	RSSI, dBm	Bandwidth, MHz
!!!!Esh_test1111	AP	wpa	CC:9D:A2:C7:A2:E0	1	-39	20
EltexWiFi	AP	off	E0:D9:E3:49:D5:00	1	-50	20
Eltex-WLC-Local	AP	wpa	CC:9D:A2:FF:B2:03	6	-68	20
TEst_Ent	AP	wpa	CC:9D:A2:C7:DF:D0	11	-75	20
sdd_wlc_enterprise	AP	wpa	E8:28:C1:FC:D6:41	1	-77	20
WLC30_sdd1	AP	wpa	E8:28:C1:FC:D6:40	1	-77	20
WLC	AP	off	E0:D9:E3:49:79:01	1	-77	20
Rostelecom	AP	off	E8:28:C1:EC:DE:21	11	-78	20
VIP_test	AP	off	E0:D9:E3:73:06:F2	6	-79	20
i-cisco-ent	AP	wpa	7C:21:0E:E2:76:C0	1	-80	20
Test_Astra_Ted	AP	off	E4:5A:D4:E4:D3:F3	1	-80	20
Karandashev_Enterprise	AP	wpa	E0:D9:E3:73:06:F3	6	-80	20
i-cis-MAB	AP	off	7C:21:0E:E2:76:C2	1	-80	20

### 6.9.9 Spectrum analyzer

The spectrum analyzer provides information on channel congestion in the 2.4 and 5 GHz bands. The result is displayed as a percentage.

⚠ While the spectrum analyzer is running, all clients are disconnected from the access point. Clients will only reconnect when the spectrum analyzer has finished its work.  
The analysis time for all radio channels of two bands is approximately 5 minutes.

✓ The spectrum analyzer operates only on those channels that are specified in the `limit-channels` parameter in the radio interface settings. For example, if the channels '1 6 11' are specified in the `limit-channels` on `wlan0`, and the channels '36 40 44 48' are specified on `wlan1`, then the spectrum analysis will be performed only for channels 1, 6, 11, 36, 40, 44, 48.

In order to analyze all channels of the range on which the radio interface operates, change the value of the `use-limit-channels` parameter in the settings of each radio interface to `false`. After receiving the results of the spectrum analyzer, set the `use-limit-channels` value back to the original value `true`.  
For more information on configuring the radio interface through the CLI, see the [Radio configuration](#) section.

WEP-200L(root):/# **monitoring spectrum-analyzer**

Channel	CCA
1	81%
2	40%
3	14%
4	10%
5	36%
6	60%
7	40%
8	8%
9	14%
10	38%
11	75%
12	37%
13	18%
36	14%
40	12%
44	10%
48	18%
52	3%
56	5%
60	8%
64	6%
132	0%
136	0%
140	0%
144	1%
149	30%
153	1%
157	3%
161	2%
165	1%

## 7 The list of changes

Document version	Issue date	Revisions
Version 1.4	11.2023	<p>Synchronization with firmware version 2.3.2</p> <p>Added:</p> <ul style="list-style-type: none"> <li>• 6.9.4 Certificate information</li> </ul> <p>Changed:</p> <ul style="list-style-type: none"> <li>• 5.4.8 "Device Information" submenu</li> <li>• 5.6.2 "VAP" submenu</li> <li>• 6.3 Virtual Wi-Fi access points (VAP) configuration</li> <li>• 6.3.1 Configuration of VAP without encryption</li> <li>• 6.3.2 Configuration of VAP with WPA-Personal security mode</li> <li>• 6.3.3 Configuration of VAP with Enterprise authorization</li> <li>• 6.3.4 Configuration of VAP with Captive Portal</li> <li>• 6.3.5 Advanced VAP settings</li> <li>• 6.4 Radio configuration</li> <li>• 6.4.1 Advanced Radio settings</li> <li>• 6.6 WDS Configuration</li> <li>• 6.9.3 Device information</li> <li>• 6.9.6 Wireless interfaces</li> </ul>
Version 1.3	09.2023	<p>Synchronization with firmware version 2.2.0</p> <p>Added:</p> <ul style="list-style-type: none"> <li>• 5.9.2 "AirTune" submenu</li> </ul> <p>Changed:</p> <ul style="list-style-type: none"> <li>• 5.4.4 "Scan Environment" submenu</li> <li>• 5.5.3 "Advanced" submenu</li> <li>• 5.6.2 "VAP" menu</li> <li>• 6.2 Network parameters configuration</li> <li>• 6.3.5 Advanced VAP settings</li> <li>• 6.7.6 Advanced system settings</li> <li>• 6.9.1 Wi-Fi clients</li> <li>• 6.9.4 Network information</li> </ul>
Version 1.2	04.2023	<p>Synchronization with firmware version 1.7.1</p> <p>Changed:</p> <ul style="list-style-type: none"> <li>• 6.7 System settings</li> </ul>
Version 1.1	03.2023	<p>Synchronization with firmware version 1.6.2</p> <p>Added:</p> <ul style="list-style-type: none"> <li>• 6.5 Configuring DHCP option 82</li> </ul> <p>Corrected:</p> <ul style="list-style-type: none"> <li>• 5.5 Menu "Radio"</li> <li>• 5.6.2 Submenu "VAP"</li> </ul>

Document version	Issue date	Revisions
Version 1.0	10.2022	Synchronization with firmware version 1.5.1  First issue
Firmware version 2.3.2		

## TECHNICAL SUPPORT

For technical assistance in issues related to handling Eltex Ltd. equipment, please, address to Service Center of the company:

<https://eltex-co.com/support/>

You are welcome to visit Eltex official website to get the relevant technical documentation and software, to use our knowledge base or consult a Service Center Specialist.

<http://www.eltex-co.com/>

<http://www.eltex-co.com/support/downloads/>